

Lighting Systems

Optics & Performance

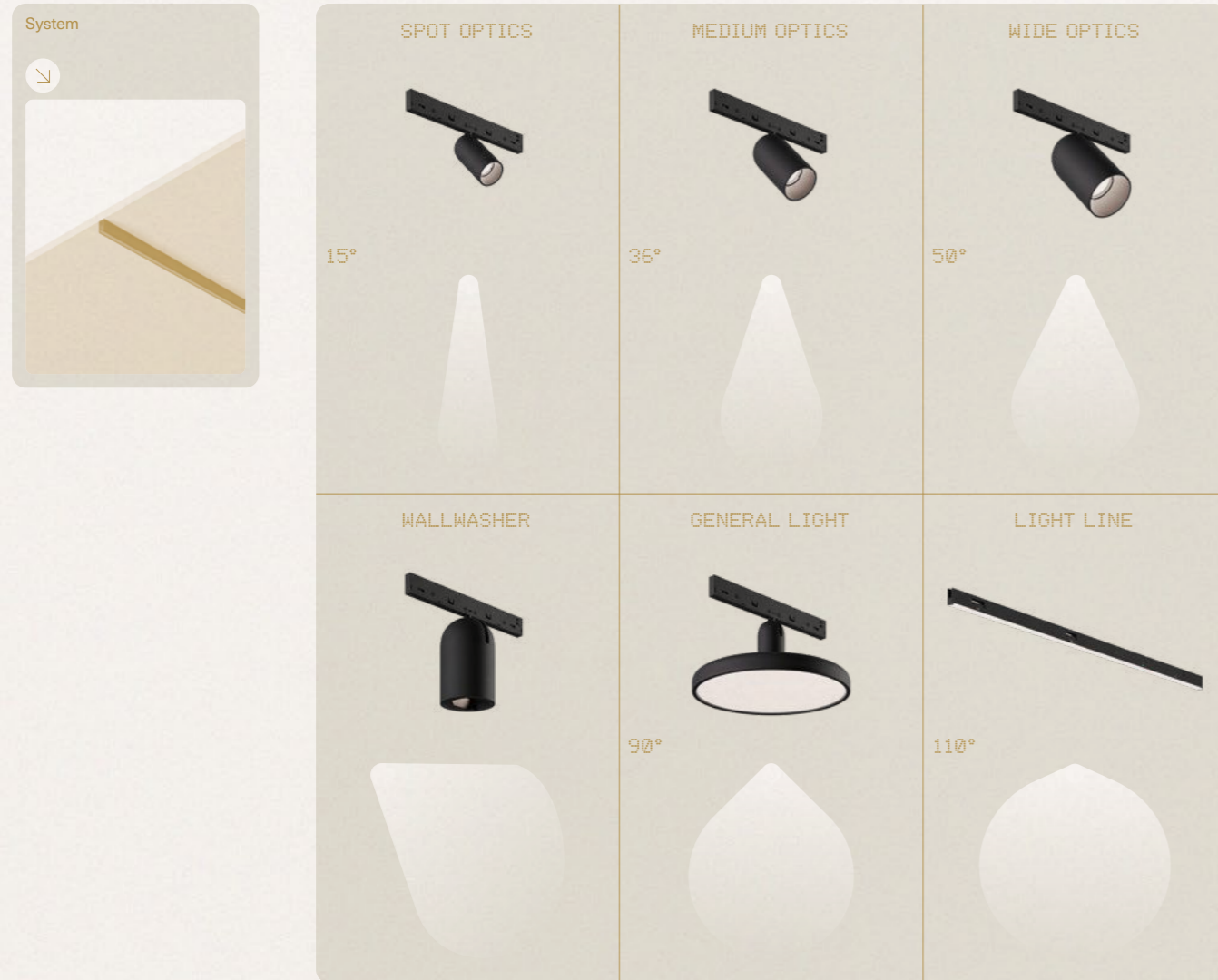

Integrated Design & Visual Comfort

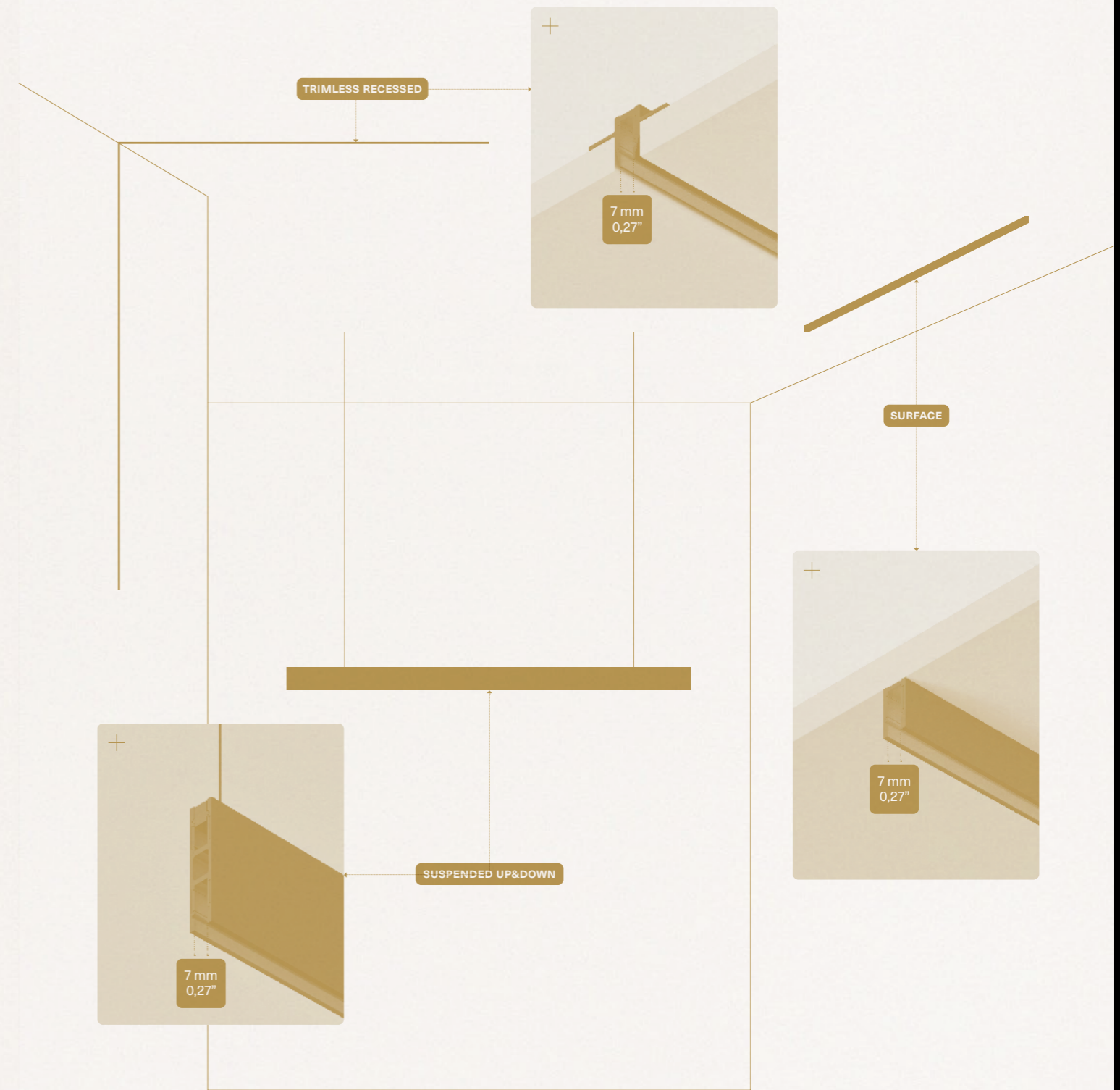

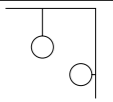

Go to the technical info 

COD.	CATEGORY	TYPE OF LIGHT
	System Sistema	Diffused symmetric light Luce simmetrica diffusa Focused light Luce focalizzata
		

NEW









is a compact 48v wallwasher spotlight for installation on the track system. The wallwasher optic is designed to provide uniform illumination of walls and vertical surfaces.





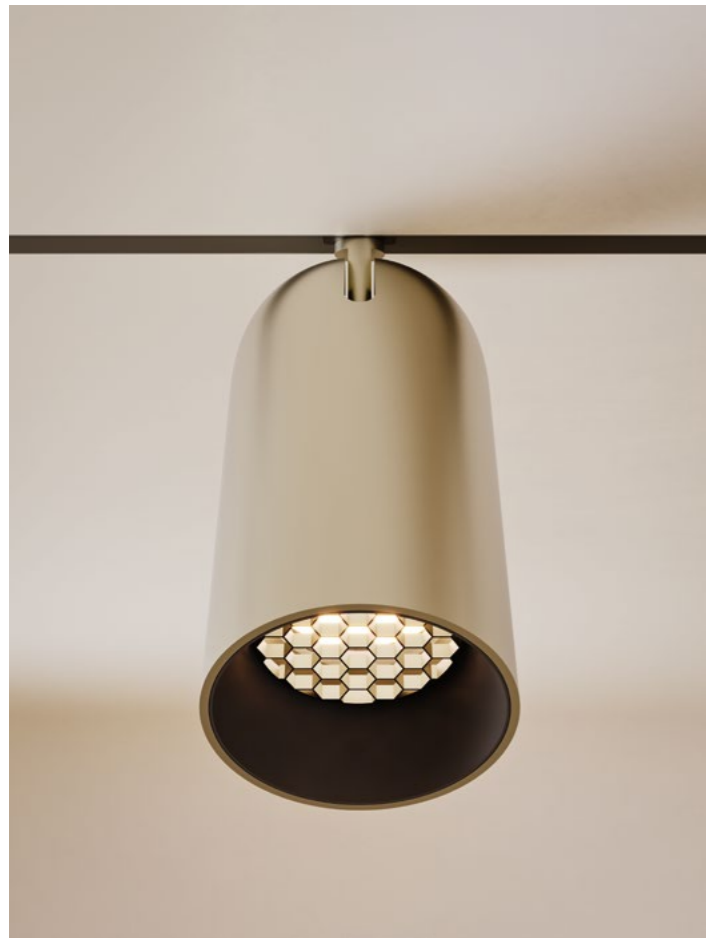

spotlights can be completed with the *honeycomb* louvre included in the package.



is the 48v light line for installation on the track system. It has a with micro-prismatic diffuser and it appears is slightly recessed into the track profile.







suspended track profile with dual emission (UP&DOWN), available in two lengths. Aesthetic finishing cover included.



is the adjustable 48v general light module with microprismatic diffuser for the track system.

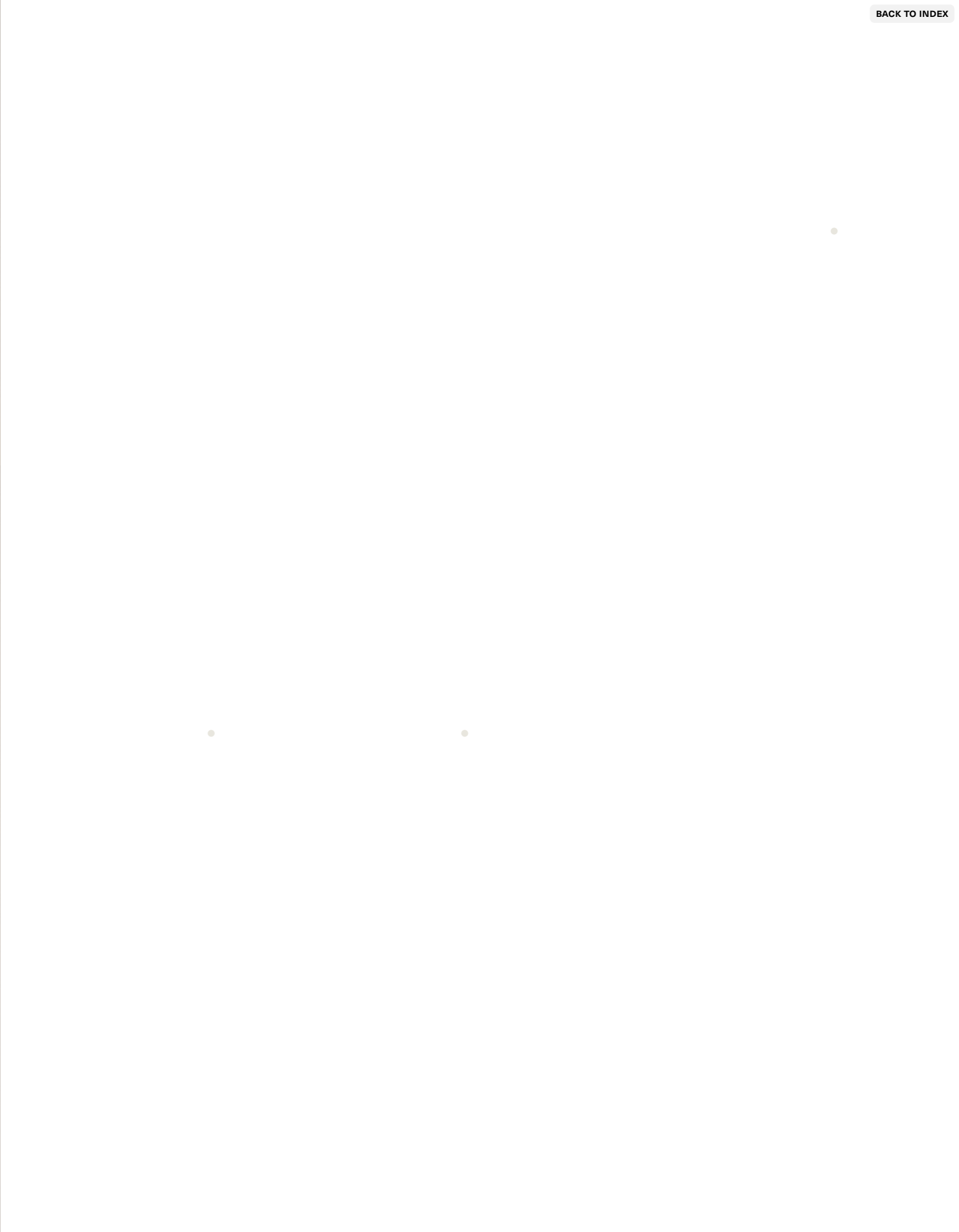

NEW

Track System

SURFACE



TRIMLESS RECESSED

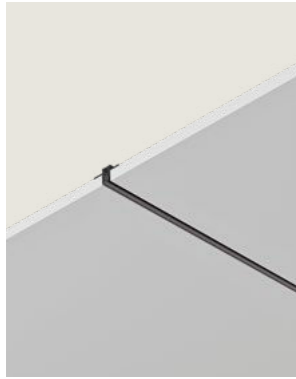

SUSPENDED UP&DOWN

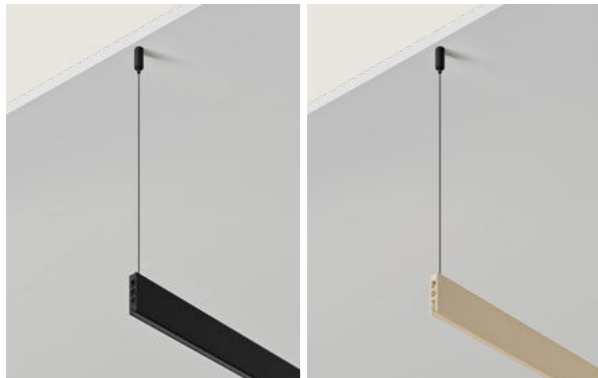

TRACK SYSTEM

TRIMLESS RECESSED

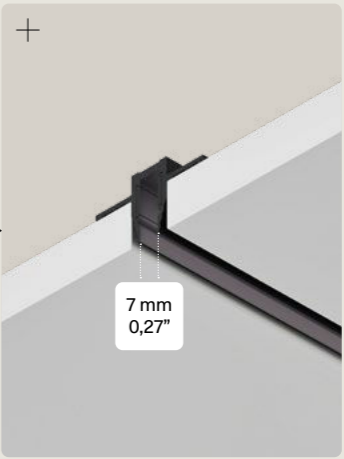

SURFACE



SUSPENDED UP&DOWN

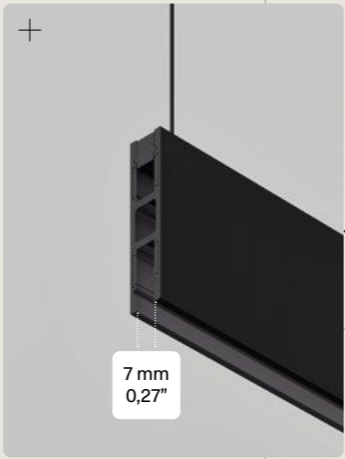

Technical info

Surface Profile

Description
Descrizione

48V track profile for surface mounting, available in three lengths. Aesthetic finishing cover included.

Profilo a binario 48V per installazione a superficie, disponibile in tre lunghezze. Cover estetica di finitura inclusa.

Metal structure
Montatura in metallo

- Extra Matte Black
Nero Extra Opaco
- Extra Matte Champagne
Champagne Extra Opaco
- Extra Matte Black
Nero Extra Opaco
- Extra Matte Champagne
Champagne Extra Opaco
- Extra Matte Black
Nero Extra Opaco
- Extra Matte Champagne
Champagne Extra Opaco

Track length
Lunghezza binario

- A **1 m - 39,37"**
- B **2 m - 78,74"**
- C **3 m - 118,11"**

Code
Codice

- A100 20**
- A100 45**
- A200 20**
- A200 45**
- A300 20**
- A300 45**

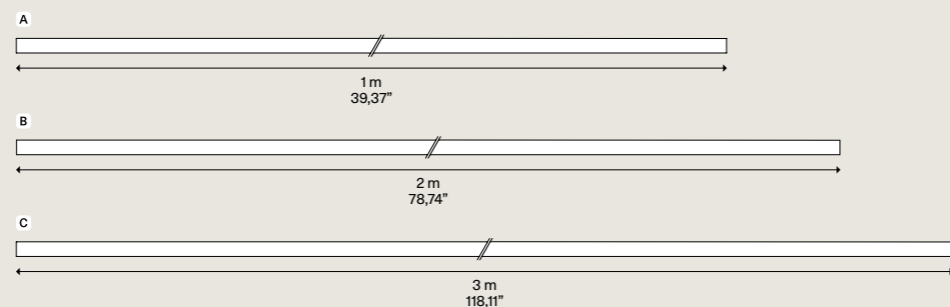
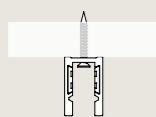
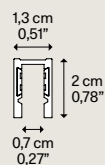

Net weight
Peso netto 280 g/m²
0,61 lbs/m² Pack
Colli 1

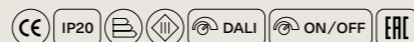

Surface 90° Curve

Description
Descrizione

90° curved element - 30 cm / 11,81" radius for the Surface track, for creating curves on the same installation plane. Aesthetic finishing cover included.

Elemento curvo a 90° - raggio 30 cm / 11,81" per il binario Surface, per realizzare curve sullo stesso piano di installazione. Cover estetica di finitura inclusa.

Metal structure
Montatura in metallo

- Extra Matte Black
Nero Extra Opaco
- Extra Matte Champagne
Champagne Extra Opaco

Track curvature
Curvatura binario

- D **90° R30**

Code
Codice

- AR30 20**
- AR30 45**

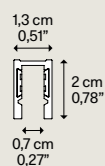
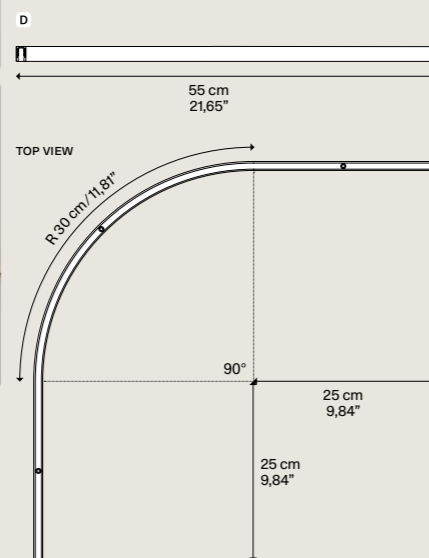

Net weight
Peso netto 210 g
0,46 lbs Pack
Colli 1

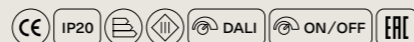

Flat Corner

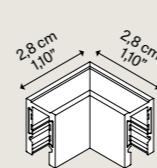

Net weight
Peso netto 10 g
0,02 lbs Pack
Colli 1

Description
Descrizione

90° corner element for connecting two Surface track sections on the same plane.

Elemento angolare a 90° per collegare due segmenti di binario Surface sullo stesso piano.

Metal structure
Montatura in metallo

- Extra Matte Black
Nero Extra Opaco
- Extra Matte Champagne
Champagne Extra Opaco

Corner
Angolo

IN-PLANE

Code
Codice

- AF90 20**
- AF90 45**

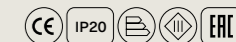

Internal Corner

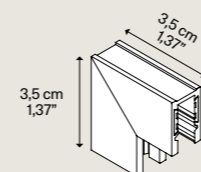

Net weight
Peso netto 10 g
0,02 lbs Pack
Colli 1

Description
Descrizione

Internal 90° corner element for connecting two Surface track sections around an inside angle.

Elemento angolare interno a 90° per collegare due segmenti di binario Surface in un angolo rientrante.

Metal structure
Montatura in metallo

- Extra Matte Black
Nero Extra Opaco
- Extra Matte Champagne
Champagne Extra Opaco

Corner
Angolo

INTERNAL

Code
Codice

- AI90 20**
- AI90 45**

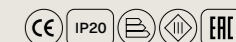

External Corner

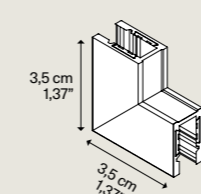

Net weight
Peso netto 10 g
0,02 lbs Pack
Colli 1

Description
Descrizione

External 90° corner element for connecting two Surface track sections around an outside angle.

Elemento angolare esterno a 90° per collegare due segmenti di binario Surface in un angolo sporgente.

Metal structure
Montatura in metallo

- Extra Matte Black
Nero Extra Opaco
- Extra Matte Champagne
Champagne Extra Opaco

Corner
Angolo

EXTERNAL

Code
Codice

- AE90 20**
- AE90 45**

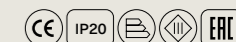

End Cap (×2)

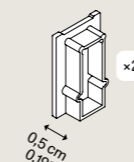

Net weight
Peso netto 5 g
0,01 lbs Pack
Colli 1

Description
Descrizione

End caps (×2) for closing the end of the Surface track.

Elementi di chiusura (×2) per terminare l'estremità del binario Surface.

Metal structure
Montatura in metallo

- Extra Matte Black
Nero Extra Opaco
- Extra Matte Champagne
Champagne Extra Opaco

Code
Codice

- AC01 20**
- AC01 45**

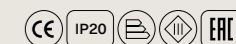

CATEGORY TRACK SYSTEM ACCESSORY **NEW**

SURFACE

Joint Connector

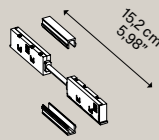

Net weight	0,15 g	Pack	1
Peso netto	0,03 lbs	Colli	

Description
Descrizione

Electrical connector ensuring power continuity between two track sections, suitable for both linear connections and corner elements.

Connettore elettrico per garantire la continuità dell'alimentazione tra due segmenti di binario, sia in connessioni lineari che negli elementi angolari.

Metal structure
Montatura in metallo

● Extra Matte Black
Nero Extra Opaco

Code
Codice

J001



Driver Box End Feed

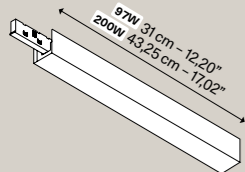

Net weight	97W	600 g	Pack	1
Peso netto		1,32 lbs	Colli	
	200W	750 g		
		1,65 lbs		

Description
Descrizione

Box with integrated 48V ON/OFF driver, featuring a single side end-feed connector for powering the track from one end.

Box con driver 48V ON/OFF integrato, dotato di connettore end-feed laterale per alimentare il binario da un'estremità.

Metal structure
Montatura in metallo

● Extra Matte Black
Nero Extra Opaco

● Extra Matte Champagne
Champagne Extra Opaco

Power
Potenza

96 w

Code
Codice

AD01 2000

AD01 4500

200 w

AD02 2000

AD02 4500

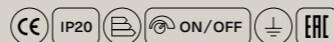

Driver Box Central Feed

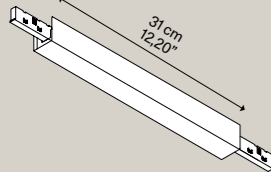

Net weight	600 g	Pack	1
Peso netto	1,32 lbs	Colli	

Description
Descrizione

48V ON/OFF driver box with dual side connectors for powering the track from a central point in both directions.

Box con driver 48V ON/OFF integrato, con doppio connettore laterale per alimentare il binario da un punto centrale in entrambe le direzioni.

Metal structure
Montatura in metallo

● Extra Matte Black
Nero Extra Opaco

● Extra Matte Champagne
Champagne Extra Opaco

Power
Potenza

96 w

Code
Codice

AD03 2000

AD03 4500

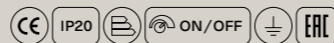
48V ON/OFF Driver
for Remote installation

Net weight	97W	160 g	Pack	1
Peso netto		0,35 lbs	Colli	
	200W	320 g		
		0,70 lbs		

Description
Descrizione

48V ON/OFF driver for remote installation, powering the track up to a total load of 96W or 200W.

Driver 48V ON/OFF per installazione remota, che alimenta il binario fino a un carico totale di 96W o 200W.

Metal structure
Montatura in metallo

● Extra Matte Black
Nero Extra Opaco

● Extra Matte Black
Nero Extra Opaco

Power
Potenza

96 w

Code
Codice

ED01 00

ED02 00

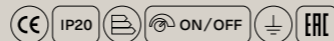
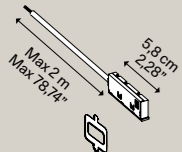
Feed Connector
for Remote-Driver installation

Net weight	100 g	Pack	1
Peso netto	0,22 lbs	Colli	

Description
Descrizione

Electrical connector for powering the track from one end in remote-driver installations and for connecting a DALI BUS. Includes an installation key for the Trimless Recessed profile.

Connettore elettrico per alimentare il binario da un'estremità nelle installazioni con driver remoto e per collegare un bus DALI. Include una chiave di installazione per il profilo Trimless Recessed.

Metal structure
Montatura in metallo

● Extra Matte Black
Nero Extra Opaco

Code
Codice

J002

CATEGORY TRACK SYSTEM **NEW**

TRIMLESS RECESSED

Trimless Recessed Profile

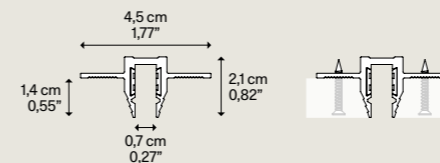

Net weight	500 g/m ²	Pack	1
Peso netto	1,10 lbs/m ²	Colli	

Description
Descrizione

48V trimless recessed track profile, available in three lengths. Aesthetic finishing cover included. Protective cover and aesthetic finishing cover included.

Profilo a binario 48V per installazione ad incasso trimless, disponibile in tre lunghezze. Cover protettiva e cover estetica di finitura incluse.

Metal structure
Montatura in metallo

● Extra Matte Black
Nero Extra Opaco

● Extra Matte Black
Nero Extra Opaco

● Extra Matte Black
Nero Extra Opaco

Track length
Lunghezza binario

A 1 m - 39,37"

B 2 m - 78,74"

C 3 m - 118,11"

Code
Codice

E100 20

E200 20

E300 20

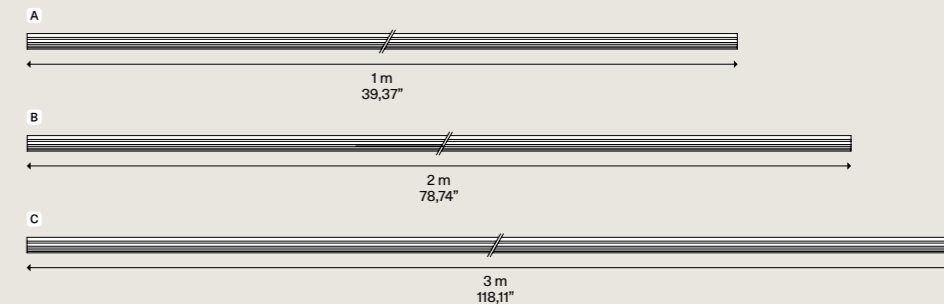

Trimless Recessed 90° Curve

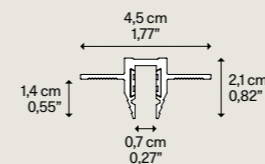

Net weight	375 g	Pack	1
Peso netto	0,82 lbs	Colli	

Description
Descrizione

90° curved element - 30 cm / 11,81" radius for the Trimless Recessed track, for creating curves on the same installation plane. Protective cover and aesthetic finishing cover included.

Elemento curvo a 90° - raggio 30 cm / 11,81" per il binario Trimless Recessed, per realizzare curve sullo stesso piano di installazione. Cover protettiva e cover estetica di finitura incluse.

Metal structure
Montatura in metallo

● Extra Matte Black
Nero Extra Opaco

Track curvature
Curvatura binario

D 90° R30

Code
Codice

ER30 20

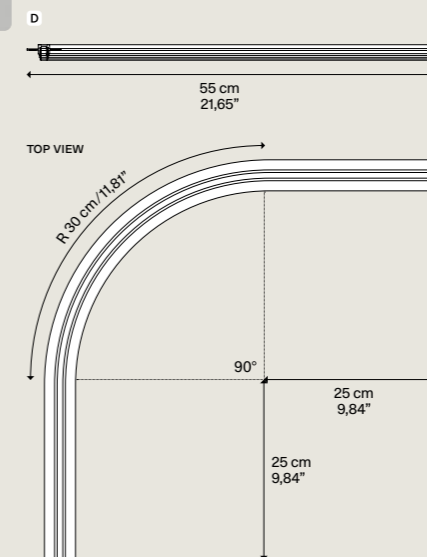

Flat Corner

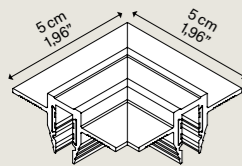

Net weight 20 g
Peso netto 0,04 lbs

Pack Colli 1

Description
Descrizione

90° corner element for connecting two Trimless Recessed track sections on the same plane.

Elemento angolare a 90° per collegare due segmenti di binario Trimless Recessed sullo stesso piano.

Metal structure
Montatura in metallo

● Extra Matte Black
Nero Extra Opaco

Corner
Angolo

IN-PLANE

Code
Codice

EF90 20

Internal Corner

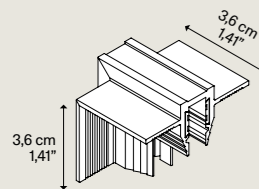

Net weight 20 g
Peso netto 0,04 lbs

Pack Colli 1

Description
Descrizione

Internal 90° corner element for connecting two Trimless Recessed track sections around an inside angle.

Elemento angolare interno a 90° per collegare due segmenti di binario Trimless Recessed in un angolo rientrante.

Metal structure
Montatura in metallo

● Extra Matte Black
Nero Extra Opaco

Corner
Angolo

INTERNAL

Code
Codice

EI90 20

External Corner

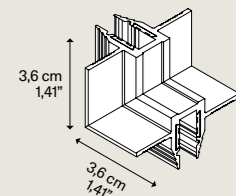

Net weight 20 g
Peso netto 0,04 lbs

Pack Colli 1

Description
Descrizione

External 90° corner element for connecting two Trimless Recessed track sections around an outside angle.

Elemento angolare esterno a 90° per collegare due segmenti di binario Trimless Recessed in un angolo sporgente.

Metal structure
Montatura in metallo

● Extra Matte Black
Nero Extra Opaco

Corner
Angolo

EXTERNAL

Code
Codice

EE90 20

Joint Connector

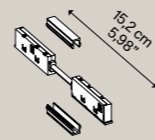

Net weight 0,15 g
Peso netto 0,03 lbs

Pack Colli 1

Description
Descrizione

Electrical connector ensuring power continuity between two track sections, suitable for both linear connections and corner elements.

Connettore elettrico per garantire la continuità dell'alimentazione tra due segmenti di binario, sia in connessioni lineari che negli elementi angolari.

Metal structure
Montatura in metallo

● Extra Matte Black
Nero Extra Opaco

Code
Codice

J001

48V ON/OFF Driver
for Remote installation

Net weight	97W	160 g	Pack	1
Peso netto		0,35 lbs	Colli	
	200W	320 g		
		0,70 lbs		

Description
Descrizione

48V ON/OFF driver for remote installation, powering the track up to a total load of 96W or 200W.

Driver 48V ON/OFF per installazione remota, che alimenta il binario fino a un carico totale di 96W o 200W.

Metal structure
Montatura in metallo

● Extra Matte Black
Nero Extra Opaco

Power
Potenza

96 w

Code
Codice

ED01 00

● Extra Matte Black
Nero Extra Opaco

200 w

ED02 00

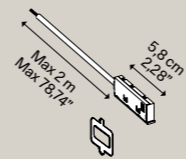
Feed Connector
for Remote-Driver installation

Net weight 100 g
Peso netto 0,22 lbs

Pack Colli 1

Description
Descrizione

Electrical connector for powering the track from one end in remote-driver installations and for connecting a DALI BUS. Includes an installation key for the Trimless Recessed profile.

Connettore elettrico per alimentare il binario da un'estremità nelle installazioni con driver remoto e per collegare un bus DALI. Include una chiave di installazione per il profilo Trimless Recessed.

Metal structure
Montatura in metallo

● Extra Matte Black
Nero Extra Opaco

Code
Codice

J002



Suspended UP&DOWN Profile



Description Descrizione	Metal structure Montatura in metallo	Track length Lunghezza binario	Code Codice
48V suspended track profile with dual emission (UP & DOWN), available in two lengths. Aesthetic finishing cover included.	● Extra Matte Black Nero Extra Opaco	A 2 m - 78,74"	H200 20
	● Extra Matte Champagne Champagne Extra Opaco		H200 45
Profilo a binario 48V sospeso a doppia emissione (UP & DOWN), disponibile in due lunghezze. Cover estetica di finitura inclusa.	● Extra Matte Black Nero Extra Opaco	C 3 m - 118,11"	H300 20
	● Extra Matte Champagne Champagne Extra Opaco		H300 45

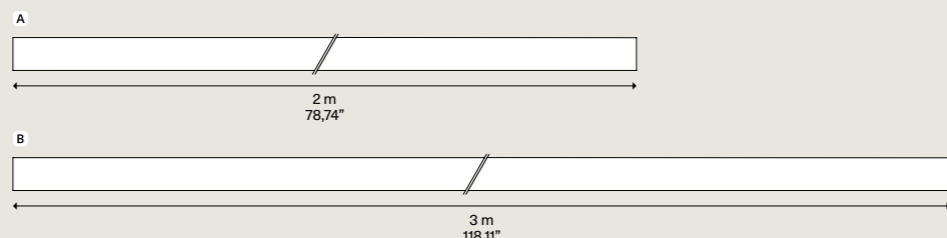
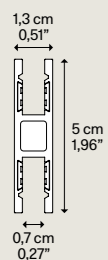

Net weight 650 g/m² / 1,43 lbs/m² | Pack Colli 1



Suspension Kit (x2)

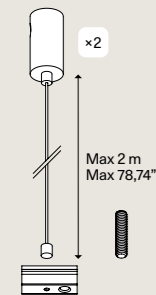

Description Descrizione	Metal structure Montatura in metallo	Code Codice
Suspension Kit (x2) - max 2 m - 78,74".	● Extra Matte Black Nero Extra Opaco	HK01 20
Suspension Kit (x2) - max 2 m - 78,74".		

Net weight 50 g / 0,11 lbs | Pack Colli 1



End Cap (x2)

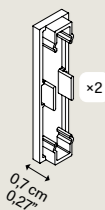

Description Descrizione	Metal structure Montatura in metallo	Code Codice
End caps (x2) for closing the end of the Suspended track.	● Extra Matte Black Nero Extra Opaco	HC01 20
Elementi di chiusura (x2) per terminare l'estremità del binario Suspended.	● Extra Matte Champagne Champagne Extra Opaco	HC01 45

Net weight 8 g / 0,01 lbs | Pack Colli 1



Joint Connector

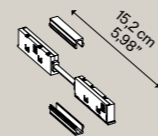

Net weight 0,15 g / 0,03 lbs | Pack Colli 1

Description Descrizione	Metal structure Montatura in metallo	Code Codice
Electrical connector ensuring power continuity between two track sections, suitable for both linear connections and corner elements.	● Extra Matte Black Nero Extra Opaco	J001
Connettore elettrico per garantire la continuità dell'alimentazione tra due segmenti di binario, sia in connessioni lineari che negli elementi angolari.		



Driver Box - Suspended

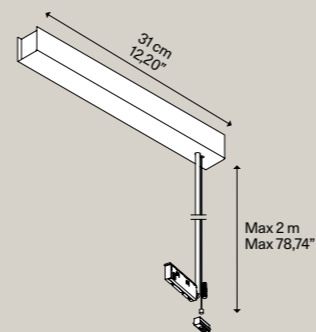

Net weight 800 g / 1,76 lbs | Pack Colli 1

Description Descrizione	Metal structure Montatura in metallo	Power Potenza	Code Codice
Box with integrated 48V ON/OFF driver, featuring a 2 m power cable with an End Feed Connector for supplying power to the suspended track from above.	● Extra Matte Black Nero Extra Opaco	96 w	HD01 2000
	● Extra Matte Champagne Champagne Extra Opaco		HD01 4500
Box con driver 48V ON/OFF integrato, dotato di un cavo di alimentazione da 2 m con Connettore End Feed per alimentare il binario sospeso dalla parte superiore.			



48V ON/OFF Driver for Remote installation

Net weight Peso netto	97W 160 g 0,35 lbs	200W 320 g 0,70 lbs	Pack Colli	1
--------------------------	--------------------------	---------------------------	---------------	---

Description Descrizione	Metal structure Montatura in metallo	Power Potenza	Code Codice
48V ON/OFF driver for remote installation, powering the track up to a total load of 96W or 200W.	● Extra Matte Black Nero Extra Opaco	96 w	ED01 00
	● Extra Matte Black Nero Extra Opaco	200 w	ED02 00
Driver 48V ON/OFF per installazione remota, che alimenta il binario fino a un carico totale di 96W o 200W.			



Feed Connector for Remote-Driver installation

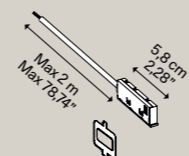

Net weight 100 g / 0,22 lbs | Pack Colli 1

Description Descrizione	Metal structure Montatura in metallo	Code Codice
Electrical connector for powering the track from one end in remote-driver installations and for connecting a DALI BUS. Includes an installation key for the Trimless Recessed profile.	● Extra Matte Black Nero Extra Opaco	J002
Connettore elettrico per alimentare il binario da un'estremità nelle installazioni con driver remoto e per collegare un bus DALI. Include una chiave di installazione per il profilo Trimless Recessed.		



Surface

A Surface Profile	P. 456
B Surface 90° Curve	P. 456
1 End Cap	P. 457
2 Joint Connector	P. 458
3 Flat Corner	P. 457
4 Internal Corner	P. 457
5 Driver Box End Feed	P. 458
6 Driver Box Central Feed	P. 458
7 48V ON/OFF Driver	P. 458
8 Feed Connector	P. 458

SURFACE

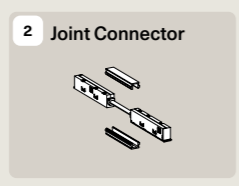
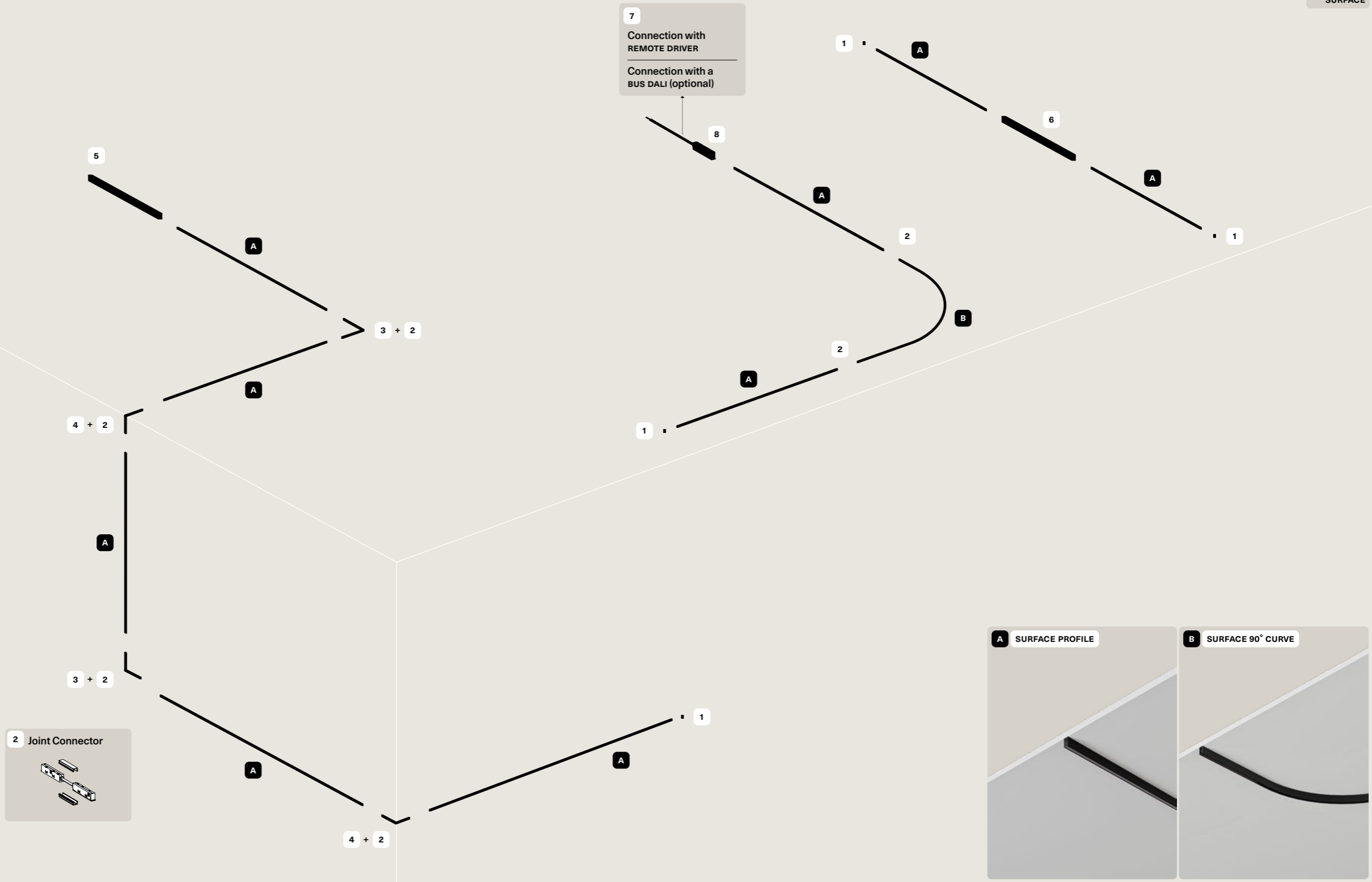

Trimless Recessed

A	Trimless Recessed Profile	P. 459
B	Trimless Recessed 90° Curve	P. 459
1	Joint Connector	P. 461
2	Flat Corner	P. 460
3	Internal Corner	P. 460
4	48V ON/OFF Driver	P. 461
5	Feed Connector	P. 461

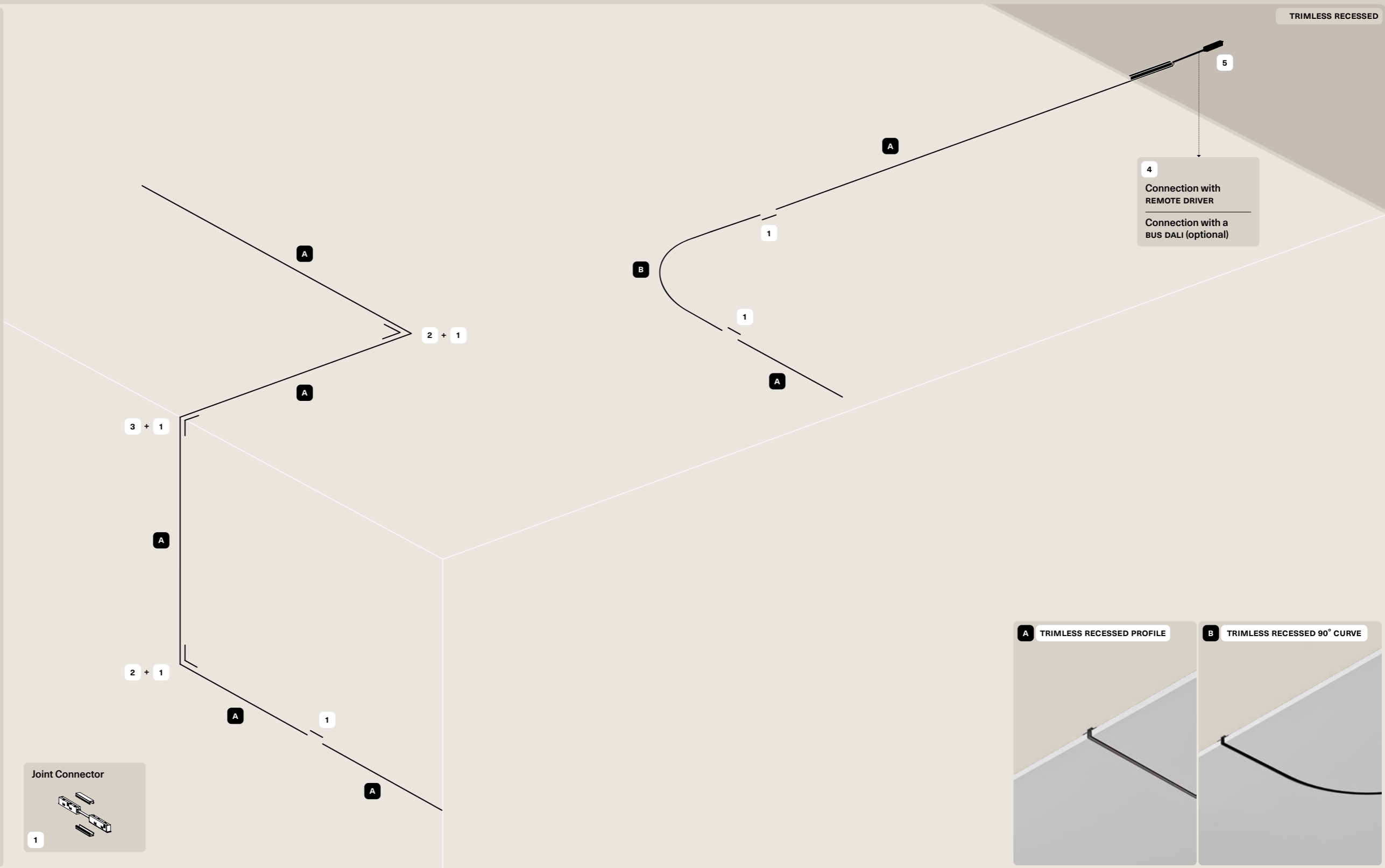

Suspended UP&DOWN

A	Suspended UP&DOWN Profile	P. 462
1	End Cap	P. 462
2	Suspension Kit	P. 462
3	Joint Connector	P. 463
4	Driver Box - Suspended	P. 463
5	48V ON/OFF Driver	P. 463
6	Feed Connector	P. 463

Up&Down Emission Doppia Emissione

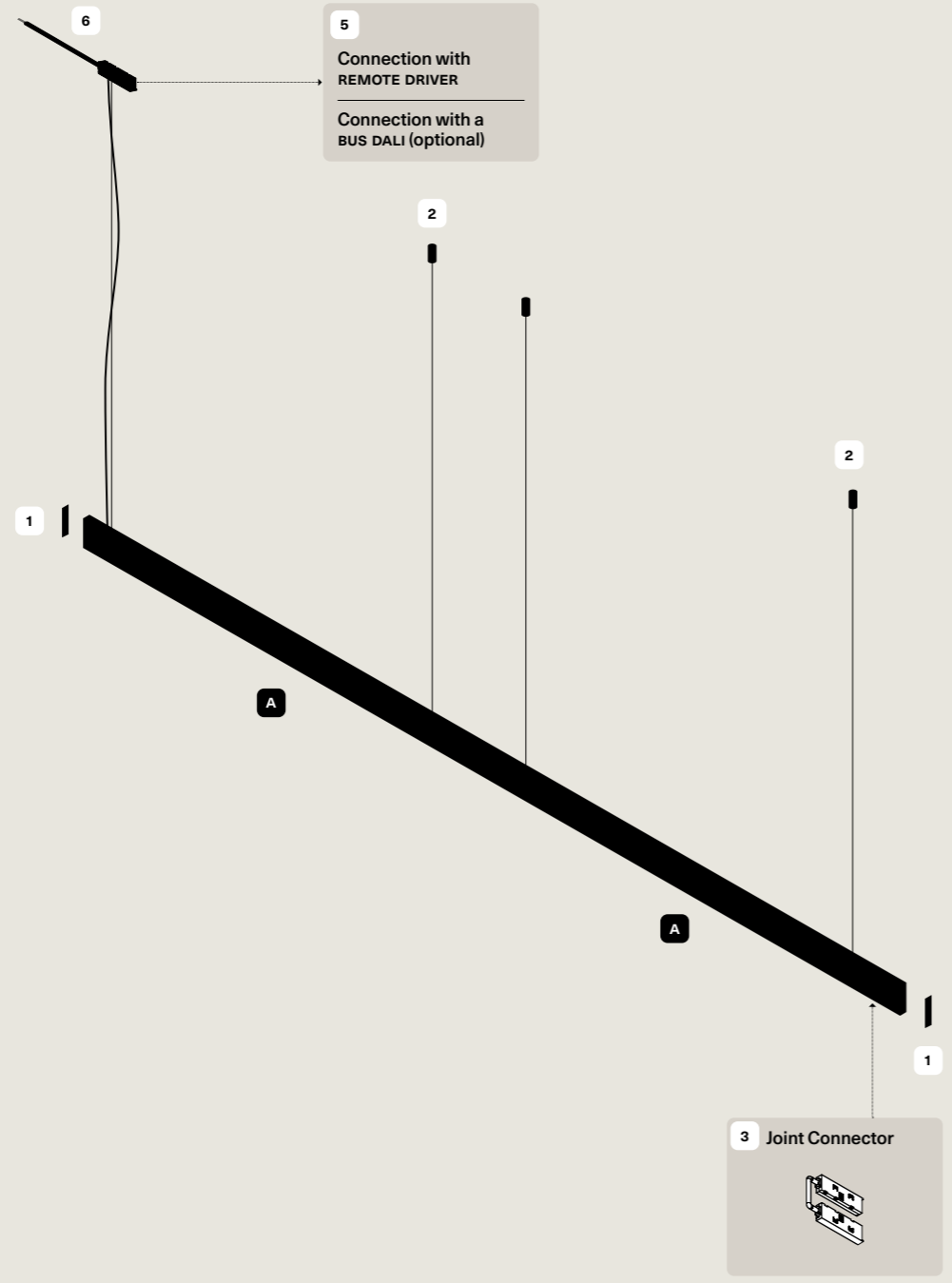

Mono (Down) Emission Mono Emissione

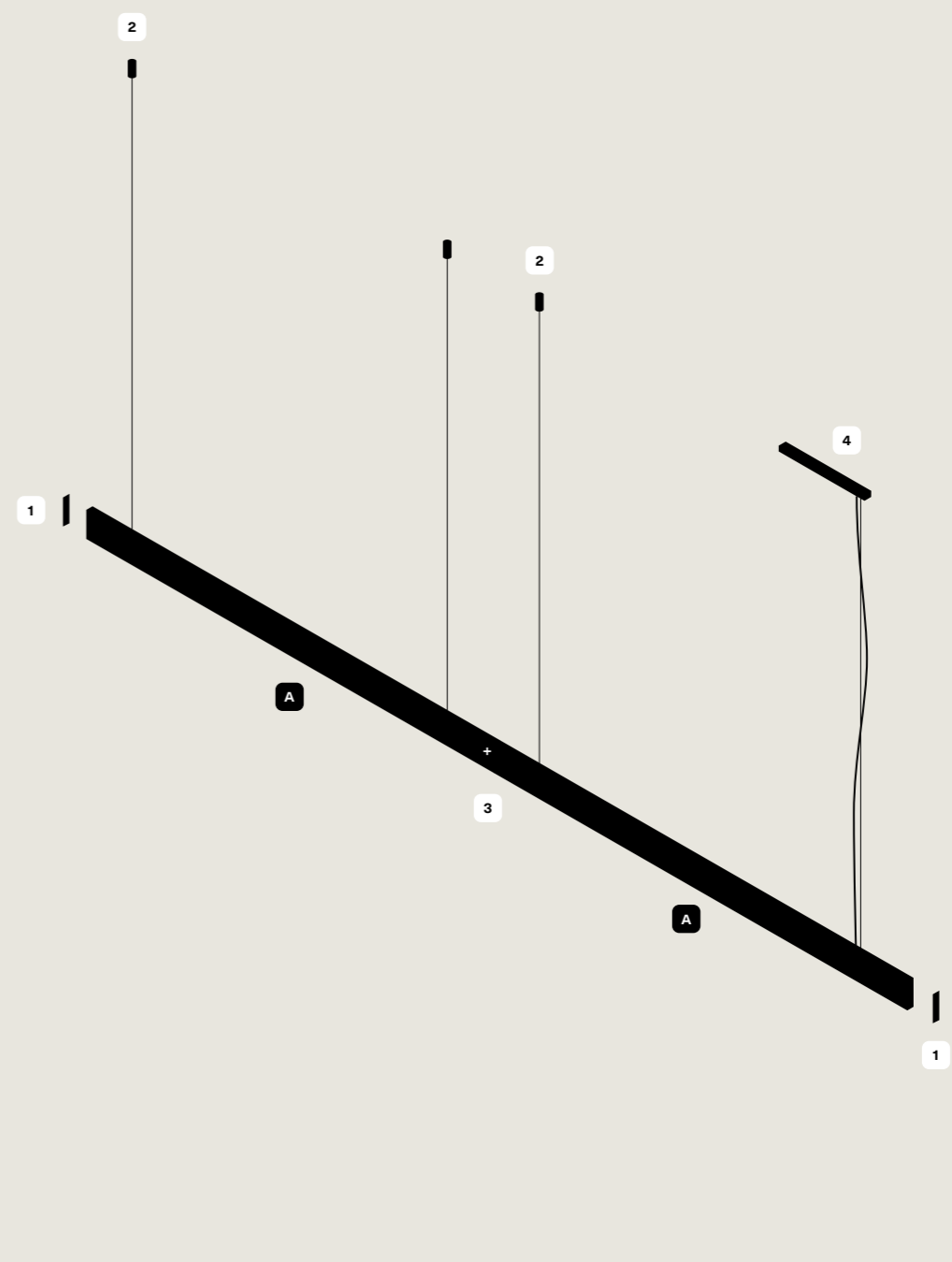

SUSPENDED UP&DOWN

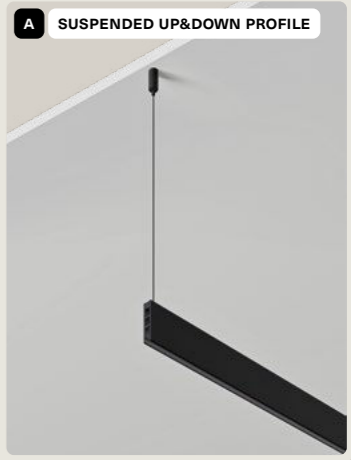

NEW

Track Light Modules

CLIP



SPOTLIGHT



WALLWASHER



GENERAL LIGHT



LIGHT LINE

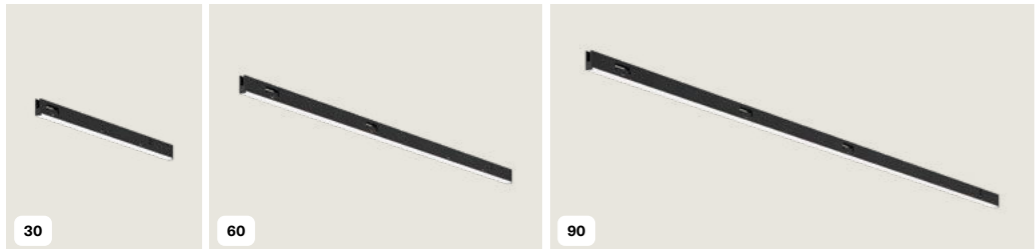

CATEGORY TRACK LIGHT MODULES NEW

Clip

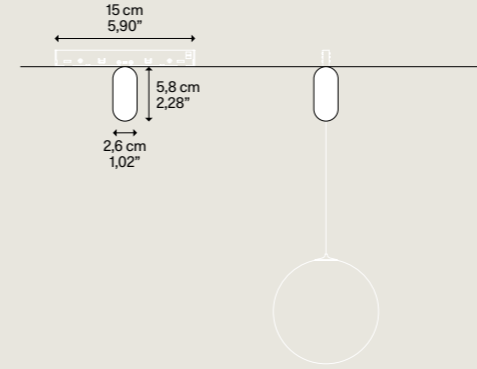

Net weight 65 g / 0,14 lbs | Pack Colli 1

Description
Descrizione

Adapter with integrated clip for connecting and installing pendants on the track. Compatible lamps are shown in the dedicated section below.
Adattatore con clip integrata per collegare e installare le sospensioni di sul binario. Le lampade compatibili sono riportate nella sezione dedicata sotto.

Metal structure
Montatura in metallo

- Extra Matte Black Nero Extra Opaco
- Extra Matte Champagne Champagne Extra Opaco
- Extra Matte Black Nero Extra Opaco
- Extra Matte Champagne Champagne Extra Opaco

Type of dimming
Tipo di dimmerazione

- DALI
- ON/OFF

Code
Codice

- 001 20
- 001 45
- 101 20
- 101 45



Lamps suitable for

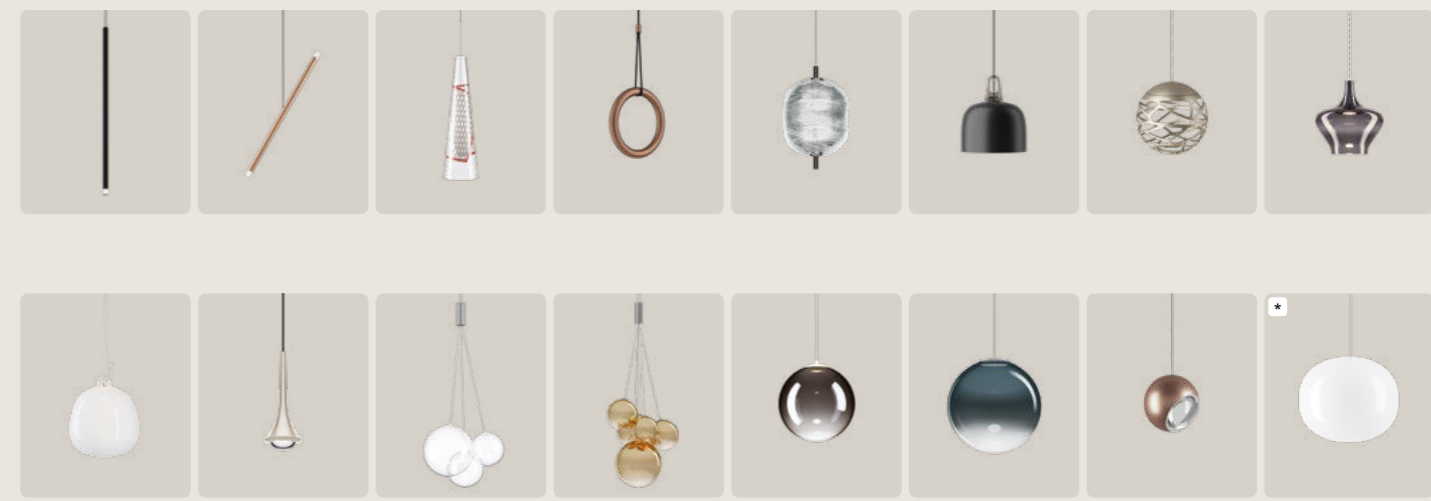

* suspensione on the / sul sistema | system must use the following bulbs, which have be ordered separately. / deve necessariamente utilizzare le seguenti lampadine, da ordinare separatamente.

Light source Sorgente luminosa	Lamp Lampada	System Sistema	Pack Colli	Code Codice
E14 5,1 W	2700 K 570 lm CRI 90 MacAdam 3-Step	14	1	-0033
E27 9,1 W	2700 K 960 lm CRI 90 MacAdam 3-Step	22	1	-0034

26 SPOTLIGHT

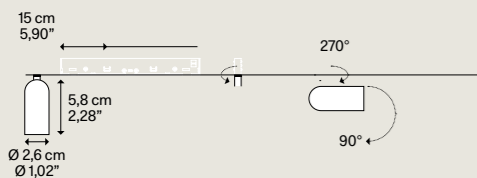

Description Descrizione	Metal structure Montatura in metallo	Type of dimming Dimmerazione	Code Codice	A	Code Codice	B
Compact 48V spotlight for the track system.	● Extra Matte Black Nero Extra Opaco		061 2027		061 2030	
	● Extra Matte Champagne Champagne Extra Opaco		061 4527		061 4530	
Proiettore compatto a 48V per installazione su binario	● Extra Matte Black Nero Extra Opaco		161 2027		161 2030	
	● Extra Matte Champagne Champagne Extra Opaco		161 4527		161 4530	
Optics Ottica	Beam angle Angolo del fascio					
The product is supplied with three interchangeable optics and an integrated honeycomb louvre.	15° SPOT 36° MEDIUM 50° WIDE HONEYCOMB LOUVRE					
Il prodotto viene fornito con tre ottiche intercambiabili e filtro honeycomb inclusi.						
Light source Sorgente luminosa A	Light source Sorgente luminosa B					
LED 2700 K 4 W 512 lm CRI 90 MacAdam 3-Step	LED 3000 K 4 W 528 lm CRI 90 MacAdam 3-Step					

Net weight 120 g / 0,26 lbs
Pack Colli 1



35 SPOTLIGHT

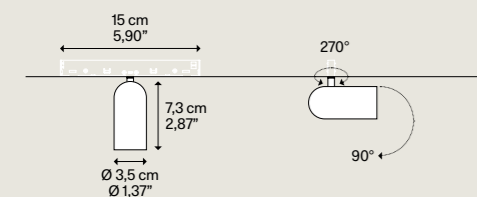

Description Descrizione	Metal structure Montatura in metallo	Type of dimming Dimmerazione	Code Codice	A	Code Codice	B
Compact 48V spotlight for the track system.	● Extra Matte Black Nero Extra Opaco		062 2027		062 2030	
	● Extra Matte Champagne Champagne Extra Opaco		062 4527		062 4530	
Proiettore compatto a 48V per installazione su binario	● Extra Matte Black Nero Extra Opaco		162 2027		162 2030	
	● Extra Matte Champagne Champagne Extra Opaco		162 4527		162 4530	
Optics Ottica	Beam angle Angolo del fascio					
The product is supplied with three interchangeable optics and an integrated honeycomb louvre.	15° SPOT 36° MEDIUM 50° WIDE HONEYCOMB LOUVRE					
Il prodotto viene fornito con tre ottiche intercambiabili e filtro honeycomb inclusi.						
Light source Sorgente luminosa A	Light source Sorgente luminosa B					
LED 2700 K 8 W 768 lm CRI 90 MacAdam 3-Step	LED 3000 K 8 W 792 lm CRI 90 MacAdam 3-Step					

Net weight 120 g / 0,26 lbs
Pack Colli 1



45 SPOTLIGHT

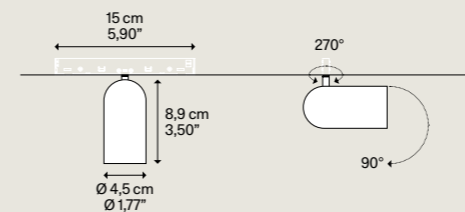

Description Descrizione	Metal structure Montatura in metallo	Type of dimming Dimmerazione	Code Codice	A	Code Codice	B
Compact 48V spotlight for the track system.	● Extra Matte Black Nero Extra Opaco		063 2027		063 2030	
	● Extra Matte Champagne Champagne Extra Opaco		063 4527		063 4530	
Proiettore compatto a 48V per installazione su binario	● Extra Matte Black Nero Extra Opaco		163 2027		163 2030	
	● Extra Matte Champagne Champagne Extra Opaco		163 4527		163 4530	
Optics Ottica	Beam angle Angolo del fascio					
The product is supplied with three interchangeable optics and an integrated honeycomb louvre.	15° SPOT 36° MEDIUM 50° WIDE HONEYCOMB LOUVRE					
Il prodotto viene fornito con tre ottiche intercambiabili e filtro honeycomb inclusi.						
Light source Sorgente luminosa A	Light source Sorgente luminosa B					
LED 2700 K 12 W 1340 lm CRI 90 MacAdam 3-Step	LED 3000 K 12 W 1390 lm CRI 90 MacAdam 3-Step					

Net weight 220 g / 0,48 lbs
Pack Colli 1



WALLWASHER

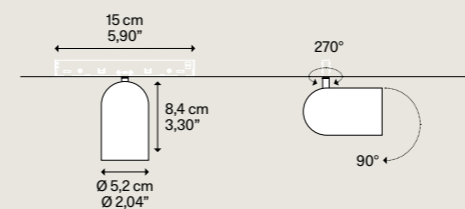

Description Descrizione	Metal structure Montatura in metallo	Type of dimming Dimmerazione	Code Codice	A	Code Codice	B
Compact 48V wallwasher spotlight for installation on the track system.	● Extra Matte Black Nero Extra Opaco		051 2027		051 2030	
	● Extra Matte Champagne Champagne Extra Opaco		051 4527		051 4530	
Proiettore compatto wallwasher a 48V per installazione su binario	● Extra Matte Black Nero Extra Opaco		151 2027		151 2030	
	● Extra Matte Champagne Champagne Extra Opaco		151 4527		151 4530	
Optics Ottica	Beam angle Angolo del fascio					
The wallwasher optic is designed to provide uniform illumination of walls and vertical surfaces.	WALLWASHER					
L'ottica wallwasher è progettata per garantire un'illuminazione uniforme di pareti e superfici verticali.						
Light source Sorgente luminosa A	Light source Sorgente luminosa B					
LED 2700 K 10 W 1970 lm CRI 90 MacAdam 3-Step	LED 3000 K 10 W 2100 lm CRI 90 MacAdam 3-Step					

Net weight 260 g / 0,57 lbs
Pack Colli 1



GENERAL LIGHT



Description Descrizione	Metal structure Montatura in metallo	Type of dimming Dimmerazione	Code Codice	A	Code Codice	B
Adjustable 48V general light module with micro-prismatic diffuser for the track system.	● Extra Matte Black Nero Extra Opaco		031 2027		031 2030	
	● Extra Matte Champagne Champagne Extra Opaco		031 4527		031 4530	
Modulo orientabile a luce diffusa 48V con diffusore microprismatico, per installazione su binario	● Extra Matte Black Nero Extra Opaco		131 2027		131 2030	
	● Extra Matte Champagne Champagne Extra Opaco		131 4527		131 4530	

Beam angle
Angolo del fascio

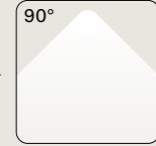

WIDE

Light source
Sorgente luminosa

LED	K	W	lm	MacAdam 3-Step
2700	8	1896	CRI 90	MacAdam 3-Step

Light source
Sorgente luminosa

LED	K	W	lm	MacAdam 3-Step
3000	8	1902	CRI 90	MacAdam 3-Step

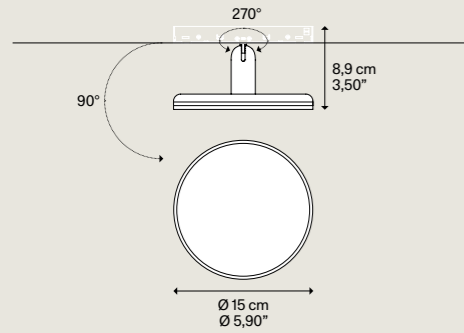

Net weight 360 g / Peso netto 0,79 lbs
Pack Colli 1



30 LIGHT LINE

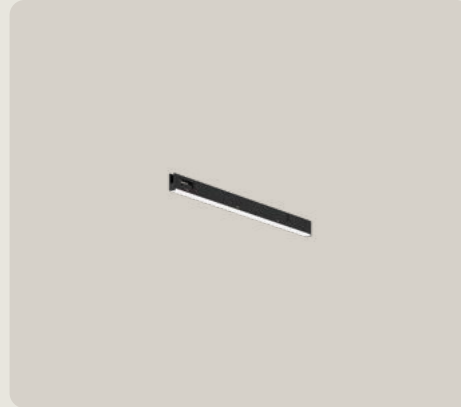

Description Descrizione	Metal structure Montatura in metallo	Type of dimming Dimmerazione	Code Codice	A	Code Codice	B
48V light line for installation on the track system, 30 cm / 11,81" length.	● Extra Matte Black Nero Extra Opaco		091 27		091 30	
	● Extra Matte Black Nero Extra Opaco		191 27		191 30	

Light source
Sorgente luminosa

LED	K	W	lm	MacAdam 3-Step
2700	4	532	CRI 90	MacAdam 3-Step

Light source
Sorgente luminosa

LED	K	W	lm	MacAdam 3-Step
3000	4	544	CRI 90	MacAdam 3-Step

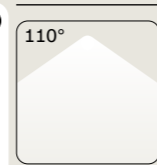

EXTRA WIDE

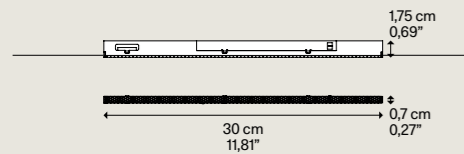

Net weight 60 g / Peso netto 0,13 lbs
Pack Colli 1



60 LIGHT LINE



Description Descrizione	Metal structure Montatura in metallo	Type of dimming Dimmerazione	Code Codice	A	Code Codice	B
48V light line for installation on the track system, 60 cm / 23,62" length.	● Extra Matte Black Nero Extra Opaco		092 27		092 30	
	● Extra Matte Black Nero Extra Opaco		192 27		192 30	

Light source
Sorgente luminosa

LED	K	W	lm	MacAdam 3-Step
2700	8	1064	CRI 90	MacAdam 3-Step

Light source
Sorgente luminosa

LED	K	W	lm	MacAdam 3-Step
3000	8	1088	CRI 90	MacAdam 3-Step

Beam angle
Angolo del fascio

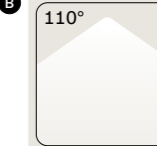

EXTRA WIDE

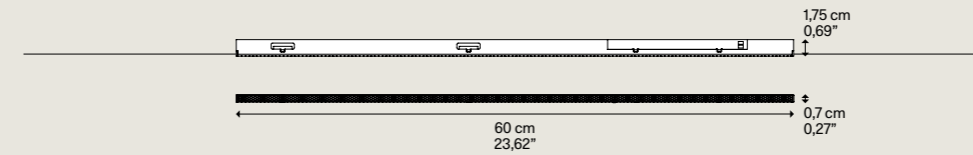

Net weight 100 g / Peso netto 0,22 lbs
Pack Colli 1



90 LIGHT LINE



Description Descrizione	Metal structure Montatura in metallo	Type of dimming Dimmerazione	Code Codice	A	Code Codice	B
48V light line for installation on the track system, 90 cm / 35,43" length.	● Extra Matte Black Nero Extra Opaco		093 27		093 30	
	● Extra Matte Black Nero Extra Opaco		193 27		193 30	

Light source
Sorgente luminosa

LED	K	W	lm	MacAdam 3-Step
2700	12	1596	CRI 90	MacAdam 3-Step

Light source
Sorgente luminosa

LED	K	W	lm	MacAdam 3-Step
3000	12	1632	CRI 90	MacAdam 3-Step

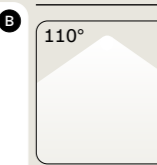

EXTRA WIDE

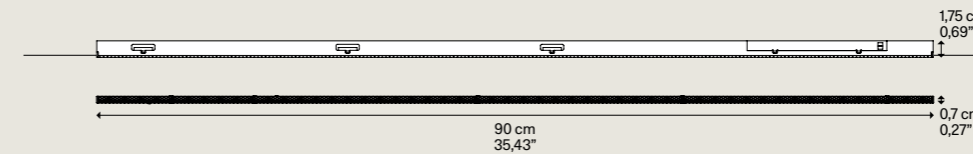

Net weight 145 g / Peso netto 0,31 lbs
Pack Colli 1

