

# Lighting Systems

## Track System **NEW**

SURFACE

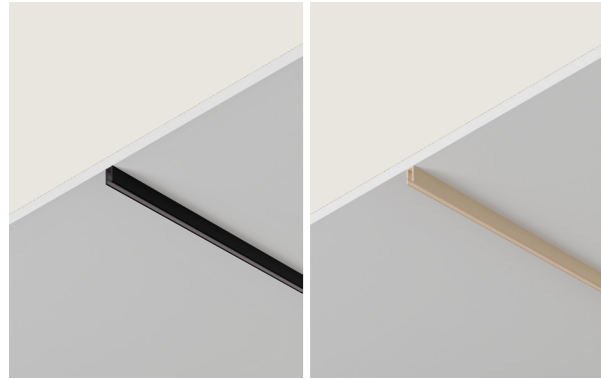

TRIMLESS RECESSED

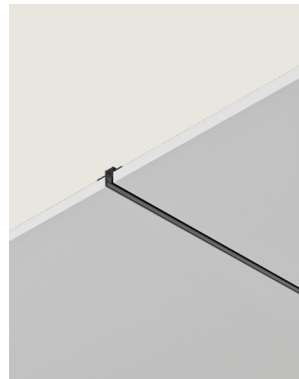

SUSPENDED UP&DOWN

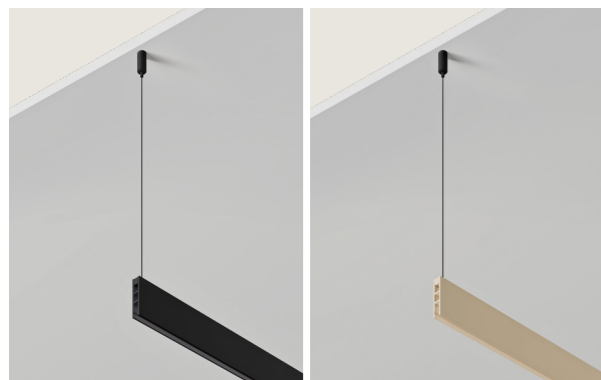

TRACK SYSTEM

TRIMLESS RECESSED

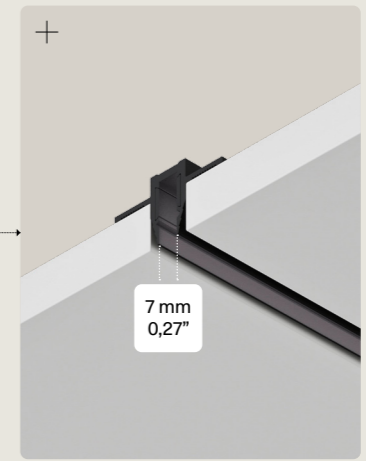

SURFACE

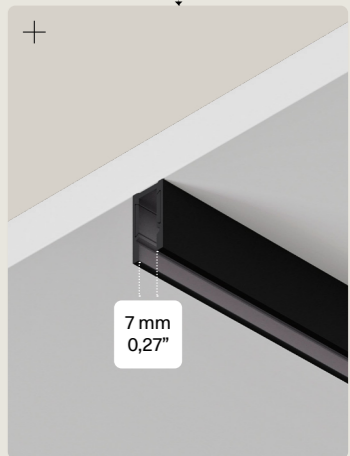

SUSPENDED UP&DOWN

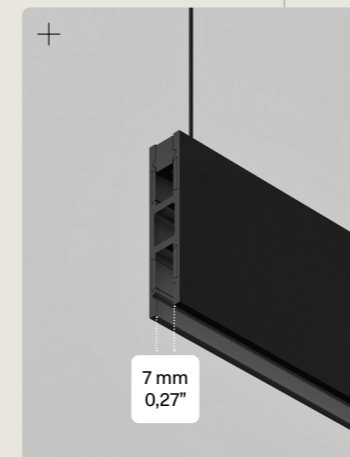

### Surface Profile



Description Descrizione	Metal structure Montatura in metallo	Track length Lunghezza binario	Code Codice	Euro €
48V track profile for surface mounting, available in three lengths. Aesthetic finishing cover included.	● Extra Matte Black Nero Extra Opaco	A 1 m - 39,37"	A100 20	60,00
	● Extra Matte Champagne Champagne Extra Opaco		A100 45	70,00
Profilo a binario 48V per installazione a superficie, disponibile in tre lunghezze. Cover esteticadi finitura inclusa.	● Extra Matte Black Nero Extra Opaco	B 2 m - 78,74"	A200 20	120,00
	● Extra Matte Champagne Champagne Extra Opaco		A200 45	140,00
	● Extra Matte Black Nero Extra Opaco	C 3 m - 118,11"	A300 20	180,00
	● Extra Matte Champagne Champagne Extra Opaco		A300 45	210,00

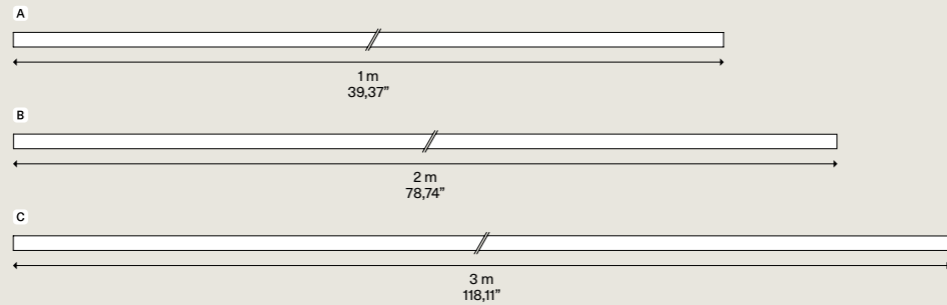
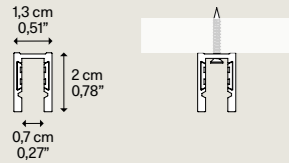

Net weight 280 g/m<sup>2</sup> / 0,61 lbs/m<sup>2</sup> | Pack Colli 1



VAT excluded IVA esclusa

### Surface 90° Curve

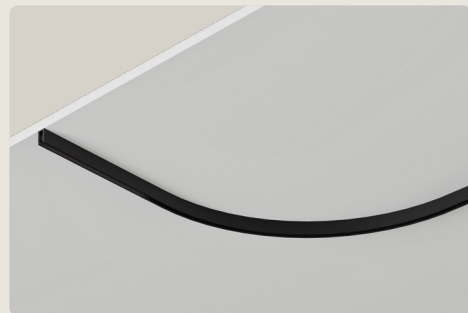

Description Descrizione	Metal structure Montatura in metallo	Track curvature Curvatura binario	Code Codice	Euro €
90° curved element - 30 cm / 11,81" radius for the Surface track, for creating curves on the same installation plane. Aesthetic finishing cover included.	● Extra Matte Black Nero Extra Opaco	D 90° R30	AR30 20	180,00
	● Extra Matte Champagne Champagne Extra Opaco		AR30 45	190,00

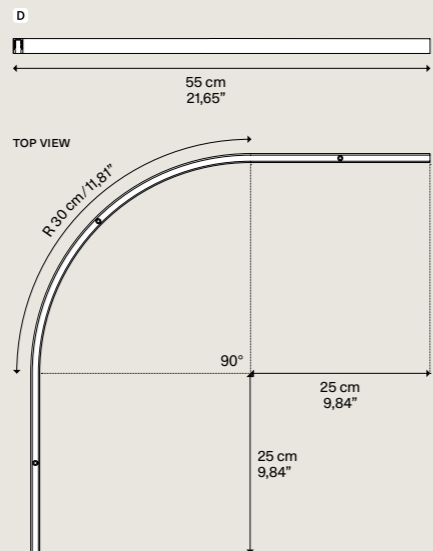

Net weight 210 g / 0,46 lbs | Pack Colli 1



### Flat Corner

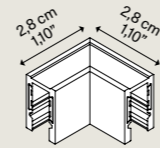

Net weight 10 g / 0,02 lbs | Pack Colli 1

Description Descrizione	Metal structure Montatura in metallo	Corner Angolo	Code Codice	Euro €
90° corner element for connecting two Surface track sections on the same plane.	● Extra Matte Black Nero Extra Opaco	IN-PLANE	AF90 20	25,00
	● Extra Matte Champagne Champagne Extra Opaco		AF90 45	35,00

Elemento angolare a 90° per collegare due segmenti di binario Surface sullo stesso piano.

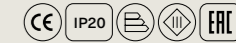

VAT excluded IVA esclusa

### Internal Corner

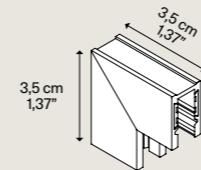

Net weight 10 g / 0,02 lbs | Pack Colli 1

Description Descrizione	Metal structure Montatura in metallo	Corner Angolo	Code Codice	Euro €
Internal 90° corner element for connecting two Surface track sections around an inside angle.	● Extra Matte Black Nero Extra Opaco	INTERNAL	AI90 20	25,00
	● Extra Matte Champagne Champagne Extra Opaco		AI90 45	35,00

Elemento angolare interno a 90° per collegare due segmenti di binario Surface in un angolo rientrante.

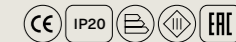

VAT excluded IVA esclusa

### External Corner

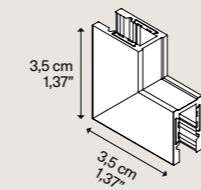

Net weight 10 g / 0,02 lbs | Pack Colli 1

Description Descrizione	Metal structure Montatura in metallo	Corner Angolo	Code Codice	Euro €
External 90° corner element for connecting two Surface track sections around an outside angle.	● Extra Matte Black Nero Extra Opaco	EXTERNAL	AE90 20	25,00
	● Extra Matte Champagne Champagne Extra Opaco		AE90 45	35,00

Elemento angolare esterno a 90° per collegare due segmenti di binario Surface in un angolo sporgente.



VAT excluded IVA esclusa

### End Cap (x2)

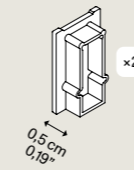

Net weight 5 g / 0,01 lbs | Pack Colli 1

Description Descrizione	Metal structure Montatura in metallo	Code Codice	Euro €
End caps (x2) for closing the end of the Surface track.	● Extra Matte Black Nero Extra Opaco	AC01 20	5,00
Elementi di chiusura (x2) per terminare l'estremità del binario Surface.	● Extra Matte Champagne Champagne Extra Opaco	AC01 45	8,00

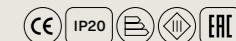

### Joint Connector

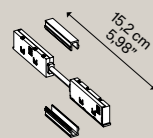

Net weight	0,15 g	Pack	1
Peso netto	0,03 lbs	Colli	

Description Descrizione	Metal structure Montatura in metallo	Code Codice	Euro €
Electrical connector ensuring power continuity between two track sections, suitable for both linear connections and corner elements.	● Extra Matte Black Nero Extra Opaco	J001	40,00

Connettore elettrico per garantire la continuità dell'alimentazione tra due segmenti di binario, sia in connessioni lineari che negli elementi angolari.



VAT excluded  
IVA esclusa

### Driver Box End Feed

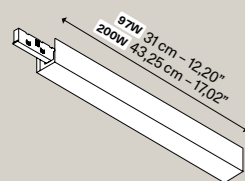

Net weight	97W	600 g	Pack	1
Peso netto		1,32 lbs	Colli	
	200W	750 g		
		1,65 lbs		

Description Descrizione	Metal structure Montatura in metallo	Power Potenza	Code Codice	Euro €
Box with integrated 48V ON/OFF driver, featuring a single side end-feed connector for powering the track from one end.	● Extra Matte Black Nero Extra Opaco	96 w	AD01 2000	160,00
	● Extra Matte Champagne Champagne Extra Opaco		AD01 4500	170,00
Box con driver 48V ON/OFF integrato, dotato di connettore end-feed laterale per alimentare il binario da un'estremità.	● Extra Matte Black Nero Extra Opaco	200 w	AD02 2000	200,00
	● Extra Matte Champagne Champagne Extra Opaco		AD02 4500	210,00

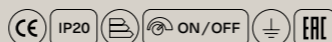

VAT excluded  
IVA esclusa

### Driver Box Central Feed

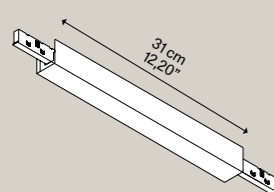

Net weight	600 g	Pack	1
Peso netto	1,32 lbs	Colli	

Description Descrizione	Metal structure Montatura in metallo	Power Potenza	Code Codice	Euro €
48V ON/OFF driver box with dual side connectors for powering the track from a central point in both directions.	● Extra Matte Black Nero Extra Opaco	96 w	AD03 2000	200,00
	● Extra Matte Champagne Champagne Extra Opaco		AD03 4500	210,00

Box con driver 48V ON/OFF integrato, con doppio connettore laterale per alimentare il binario da un punto centrale in entrambe le direzioni.



VAT excluded  
IVA esclusa

### 48V ON/OFF Driver for Remote installation

Net weight	97W	160 g	Pack	1
Peso netto		0,35 lbs	Colli	
	200W	320 g		
		0,70 lbs		

Description Descrizione	Metal structure Montatura in metallo	Power Potenza	Code Codice	Euro €
48V ON/OFF driver for remote installation, powering the track up to a total load of 96W or 200W.	● Extra Matte Black Nero Extra Opaco	96 w	ED01 00	99,00
	● Extra Matte Black Nero Extra Opaco	200 w	ED02 00	150,00

Driver 48V ON/OFF per installazione remota, che alimenta il binario fino a un carico totale di 96W o 200W.

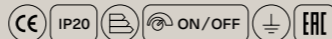

VAT excluded  
IVA esclusa

### Feed Connector for Remote-Driver installation

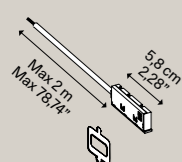

Net weight	100 g	Pack	1
Peso netto	0,22 lbs	Colli	

Description Descrizione	Metal structure Montatura in metallo	Code Codice	Euro €
Electrical connector for powering the track from one end in remote-driver installations and for connecting a DALI BUS. Includes an installation key for the Trimless Recessed profile.	● Extra Matte Black Nero Extra Opaco	J002	30,00

Connettore elettrico per alimentare il binario da un'estremità nelle installazioni con driver remoto e per collegare un bus DALI. Include una chiave di installazione per il profilo Trimless Recessed.



### Trimless Recessed Profile

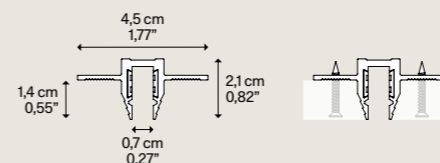
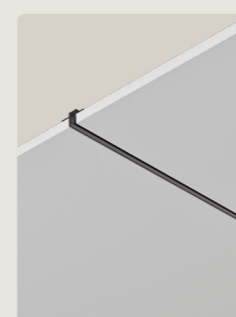

Net weight	500 g/m <sup>2</sup>	Pack	1
Peso netto	1,10 lbs/m <sup>2</sup>	Colli	

### Trimless Recessed 90° Curve

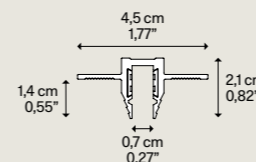

Net weight	375 g	Pack	1
Peso netto	0,82 lbs	Colli	

Description Descrizione	Metal structure Montatura in metallo	Track length Lunghezza binario	Code Codice	Euro €
48V trimless recessed track profile, available in three lengths. Aesthetic finishing cover included. Protective cover and aesthetic finishing cover included.	● Extra Matte Black Nero Extra Opaco	A 1 m - 39,37"	E100 20	60,00
	● Extra Matte Black Nero Extra Opaco	B 2 m - 78,74"	E200 20	120,00
	● Extra Matte Black Nero Extra Opaco	C 3 m - 118,11"	E300 20	180,00

Profilo a binario 48V per installazione ad incasso trimless, disponibile in tre lunghezze. Cover protettiva e cover estetica di finitura incluse.

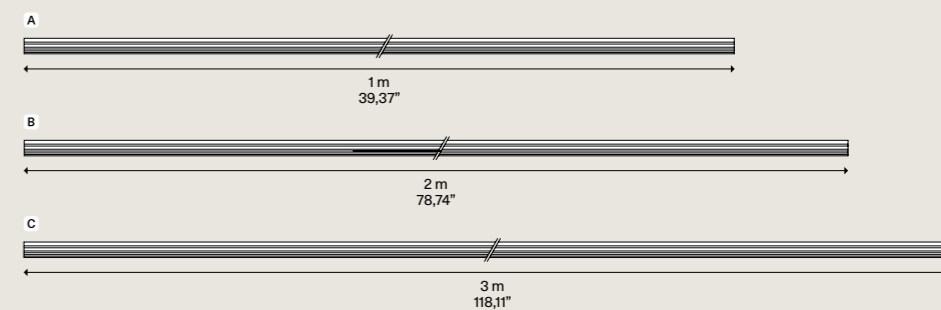

VAT excluded  
IVA esclusa

Description Descrizione	Metal structure Montatura in metallo	Track curvature Curvatura binario	Code Codice	Euro €
90° curved element - 30 cm / 11,81" radius for the Trimless Recessed track, for creating curves on the same installation plane. Protective cover and aesthetic finishing cover included.	● Extra Matte Black Nero Extra Opaco	D 90° R30	ER30 20	250,00

Elemento curvo a 90° - raggio 30 cm / 11,81" per il binario Trimless Recessed, per realizzare curve sullo stesso piano di installazione. Cover protettiva e cover estetica di finitura incluse.

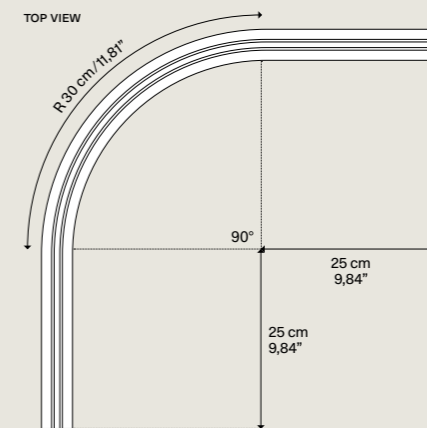
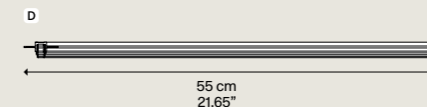

### Flat Corner

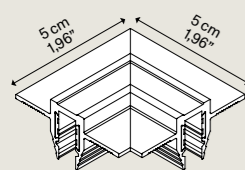

Net weight 20 g / 0,04 lbs  
Pack Colli 1

#### Description Descrizione

90° corner element for connecting two Trimless Recessed track sections on the same plane.

Elemento angolare a 90° per collegare due segmenti di binario Trimless Recessed sullo stesso piano.

#### Metal structure Montatura in metallo

● Extra Matte Black Nero Extra Opaco

#### Corner Angolo

IN-PLANE

#### Code Codice

EF90 20

#### Euro €

32,00



VAT excluded IVA esclusa

### Internal Corner

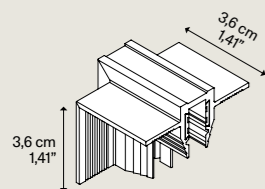

Net weight 20 g / 0,04 lbs  
Pack Colli 1

#### Description Descrizione

Internal 90° corner element for connecting two Trimless Recessed track sections around an inside angle.

Elemento angolare interno a 90° per collegare due segmenti di binario Trimless Recessed in un angolo rientrante.

#### Metal structure Montatura in metallo

● Extra Matte Black Nero Extra Opaco

#### Corner Angolo

INTERNAL

#### Code Codice

EI90 20

#### Euro €

32,00



VAT excluded IVA esclusa

### External Corner

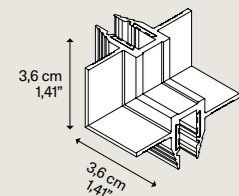

Net weight 20 g / 0,04 lbs  
Pack Colli 1

#### Description Descrizione

External 90° corner element for connecting two Trimless Recessed track sections around an outside angle.

Elemento angolare esterno a 90° per collegare due segmenti di binario Trimless Recessed in un angolo sporgente.

#### Metal structure Montatura in metallo

● Extra Matte Black Nero Extra Opaco

#### Corner Angolo

EXTERNAL

#### Code Codice

EE90 20

#### Euro €

32,00



### Joint Connector

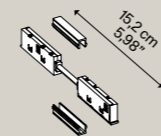

Net weight 0,15 g / 0,03 lbs  
Pack Colli 1

#### Description Descrizione

Electrical connector ensuring power continuity between two track sections, suitable for both linear connections and corner elements.

Connettore elettrico per garantire la continuità dell'alimentazione tra due segmenti di binario, sia in connessioni lineari che negli elementi angolari.

#### Metal structure Montatura in metallo

● Extra Matte Black Nero Extra Opaco

#### Code Codice

J001

#### Euro €

40,00



VAT excluded IVA esclusa

### 48V ON/OFF Driver for Remote installation

Net weight	97W	160 g	Pack	1
Peso netto		0,35 lbs	Colli	
	200W	320 g		
		0,70 lbs		

#### Description Descrizione

48V ON/OFF driver for remote installation, powering the track up to a total load of 96W or 200W.

Driver 48V ON/OFF per installazione remota, che alimenta il binario fino a un carico totale di 96W o 200W.

#### Metal structure Montatura in metallo

● Extra Matte Black Nero Extra Opaco

#### Power Potenza

96 w

#### Code Codice

ED01 00

#### Euro €

99,00

● Extra Matte Black Nero Extra Opaco

200 w

ED02 00

150,00



VAT excluded IVA esclusa

### Feed Connector for Remote-Driver installation

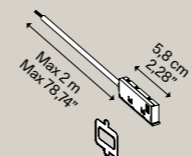

Net weight 100 g / 0,22 lbs  
Pack Colli 1

#### Description Descrizione

Electrical connector for powering the track from one end in remote-driver installations and for connecting a DALI BUS. Includes an installation key for the Trimless Recessed profile.

Connettore elettrico per alimentare il binario da un'estremità nelle installazioni con driver remoto e per collegare un bus DALI. Include una chiave di installazione per il profilo Trimless Recessed.

#### Metal structure Montatura in metallo

● Extra Matte Black Nero Extra Opaco

#### Code Codice

J002

#### Euro €

30,00



## Suspended UP&DOWN Profile

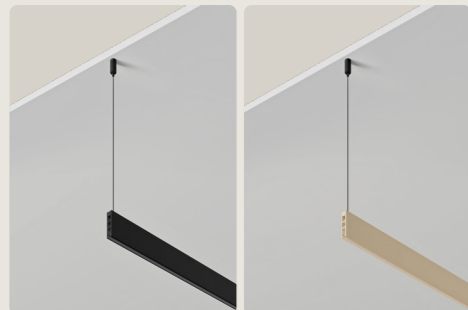

Description Descrizione	Metal structure Montatura in metallo	Track length Lunghezza binario	Code Codice	Euro €
48V suspended track profile with dual emission (UP & DOWN), available in two lengths. Aesthetic finishing cover included.	● Extra Matte Black Nero Extra Opaco	A 2 m - 78,74"	H200 20	290,00
	● Extra Matte Champagne Champagne Extra Opaco		H200 45	370,00
Profilo a binario 48V sospeso a doppia emissione (UP & DOWN), disponibile in due lunghezze. Cover estetica di finitura inclusa.	● Extra Matte Black Nero Extra Opaco	C 3 m - 118,11"	H300 20	440,00
	● Extra Matte Champagne Champagne Extra Opaco		H300 45	560,00

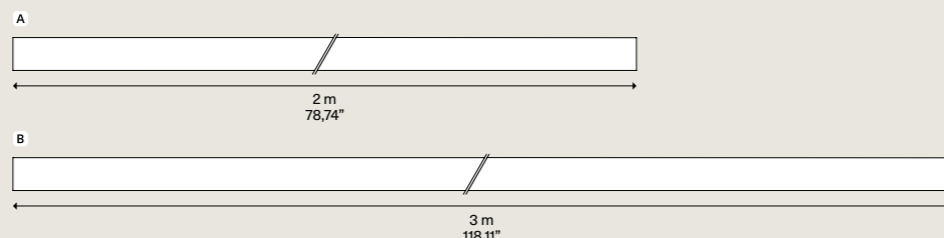
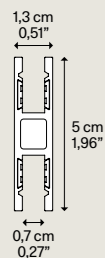

Net weight 650 g/m<sup>2</sup> / 1,43 lbs/m<sup>2</sup> | Pack Colli 1

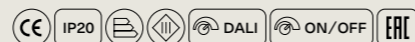

## Suspension Kit (x2)

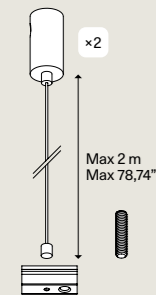

Description Descrizione	Metal structure Montatura in metallo	Code Codice	Euro €
Suspension Kit (x2) - max 2 m - 78,74"	● Extra Matte Black Nero Extra Opaco	HK01 20	24,00

Net weight 50 g / 0,11 lbs | Pack Colli 1



## End Cap (x2)

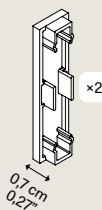

Description Descrizione	Metal structure Montatura in metallo	Code Codice	Euro €
End caps (x2) for closing the end of the Suspended track.	● Extra Matte Black Nero Extra Opaco	HC01 20	7,00
Elementi di chiusura (x2) per terminare l'estremità del binario Suspended.	● Extra Matte Champagne Champagne Extra Opaco	HC01 45	10,00

Net weight 8 g / 0,01 lbs | Pack Colli 1



## Joint Connector

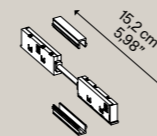

Net weight 0,15 g / 0,03 lbs | Pack Colli 1

Description Descrizione	Metal structure Montatura in metallo	Code Codice	Euro €
Electrical connector ensuring power continuity between two track sections, suitable for both linear connections and corner elements.	● Extra Matte Black Nero Extra Opaco	J001	40,00

Connettore elettrico per garantire la continuità dell'alimentazione tra due segmenti di binario, sia in connessioni lineari che negli elementi angolari.



## Driver Box - Suspended

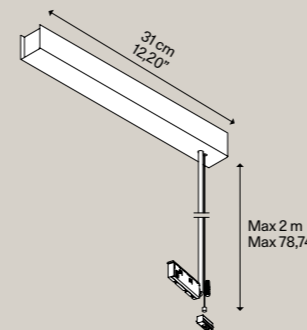

Net weight 800 g / 1,76 lbs | Pack Colli 1

Description Descrizione	Metal structure Montatura in metallo	Power Potenza	Code Codice	Euro €
Box with integrated 48V ON/OFF driver, featuring a 2 m power cable with an End Feed Connector for supplying power to the suspended track from above.	● Extra Matte Black Nero Extra Opaco	96 w	HD01 2000	180,00
	● Extra Matte Champagne Champagne Extra Opaco		HD01 4500	190,00

Box con driver 48V ON/OFF integrato, dotato di un cavo di alimentazione da 2 m con Connettore End Feed per alimentare il binario sospeso dalla parte superiore.



## 48V ON/OFF Driver for Remote installation

Net weight Peso netto	97W 160 g / 0,35 lbs	200W 320 g / 0,70 lbs	Pack Colli	1
--------------------------	-------------------------	--------------------------	---------------	---

Description Descrizione	Metal structure Montatura in metallo	Power Potenza	Code Codice	Euro €
48V ON/OFF driver for remote installation, powering the track up to a total load of 96W or 200W.	● Extra Matte Black Nero Extra Opaco	96 w	ED01 00	99,00
	● Extra Matte Black Nero Extra Opaco	200 w	ED02 00	150,00

Driver 48V ON/OFF per installazione remota, che alimenta il binario fino a un carico totale di 96W o 200W.



## Feed Connector for Remote-Driver installation

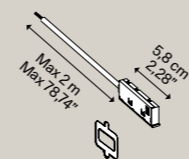

Net weight 100 g / 0,22 lbs | Pack Colli 1

Description Descrizione	Metal structure Montatura in metallo	Code Codice	Euro €
Electrical connector for powering the track from one end in remote-driver installations and for connecting a DALI BUS. Includes an installation key for the Trimless Recessed profile.	● Extra Matte Black Nero Extra Opaco	J002	30,00

Connettore elettrico per alimentare il binario da un'estremità nelle installazioni con driver remoto e per collegare un bus DALI. Include una chiave di installazione per il profilo Trimless Recessed.



# Surface

- A** Surface Profile
- B** Surface 90° Curve
- 1** End Cap
- 2** Joint Connector
- 3** Flat Corner
- 4** Internal Corner
- 5** Driver Box End Feed
- 6** Driver Box Central Feed
- 7** 48V ON/OFF Driver
- 8** Feed Connector



Easy Cut

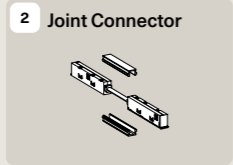

**2** Joint Connector

**7**  
 Connection with  
 REMOTE DRIVER  
 Connection with a  
 BUS DALI (optional)

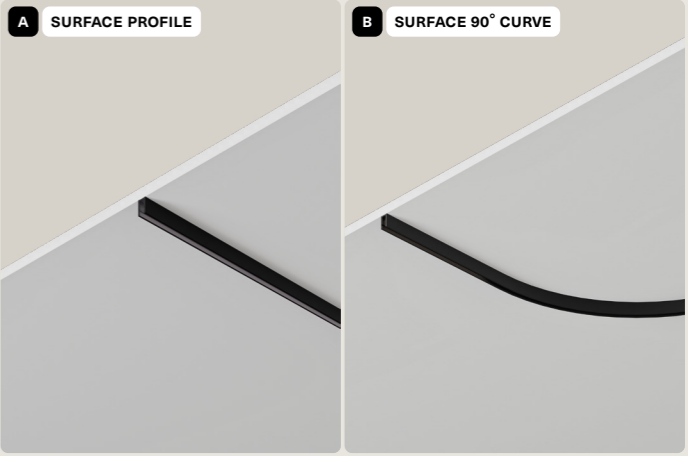
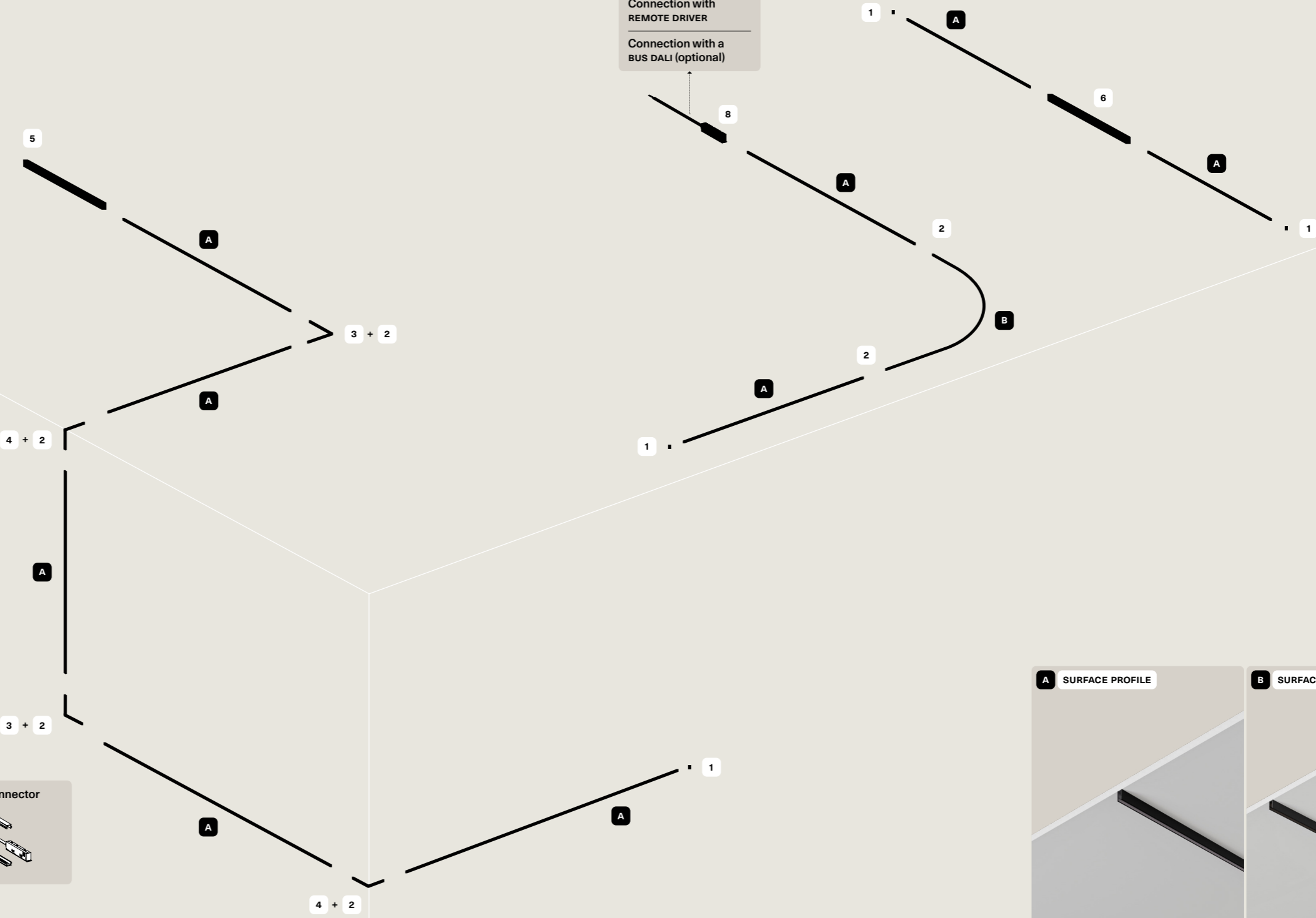

SURFACE

SYSTEM  
 ACCESSORY

# Trimless Recessed

**A** Trimless Recessed Profile

**B** Trimless Recessed 90° Curve

**1** Joint Connector

**2** Flat Corner

**3** Internal Corner

**4** 48V ON/OFF Driver

**5** Feed Connector



Easy Cut

Joint Connector

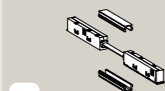

**1**

TRIMLESS RECESSED

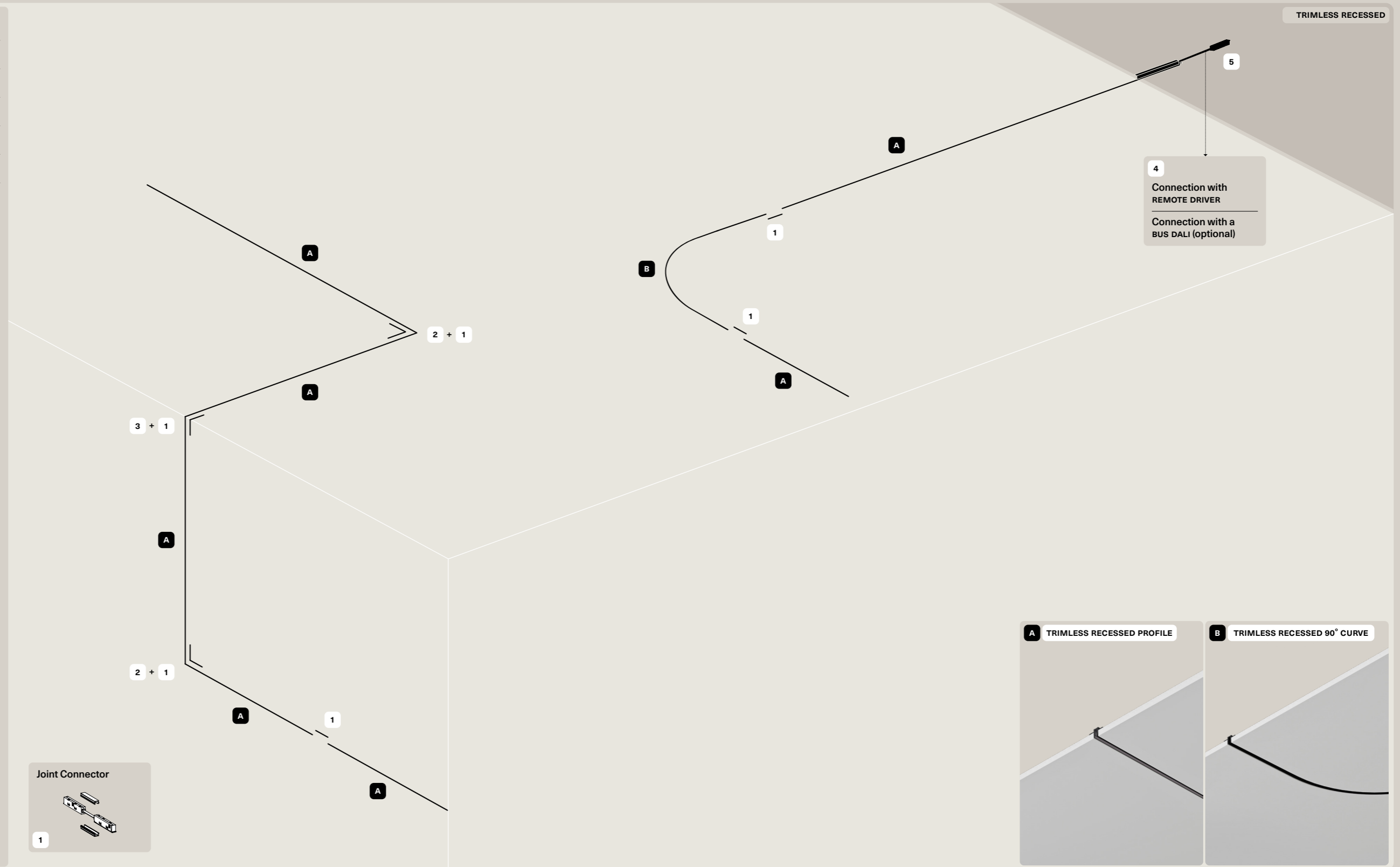

**A** TRIMLESS RECESSED PROFILE

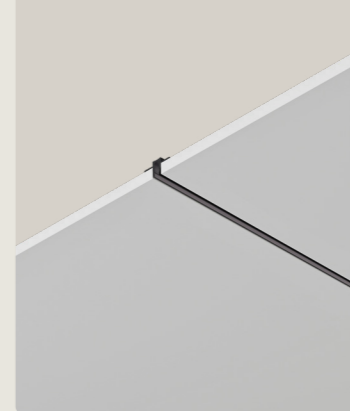

**B** TRIMLESS RECESSED 90° CURVE

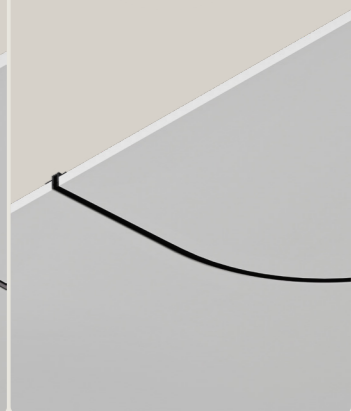

SYSTEM  
ACCESSORY

# Suspended UP&DOWN

- A** Suspended UP&DOWN Profile

---

- 1** End Cap

---

- 2** Suspension Kit

---

- 3** Joint Connector

---

- 4** Driver Box - Suspended

---

- 5** 48V ON/OFF Driver

---

- 6** Feed Connector

Up&Down Emission  
Doppia Emissione

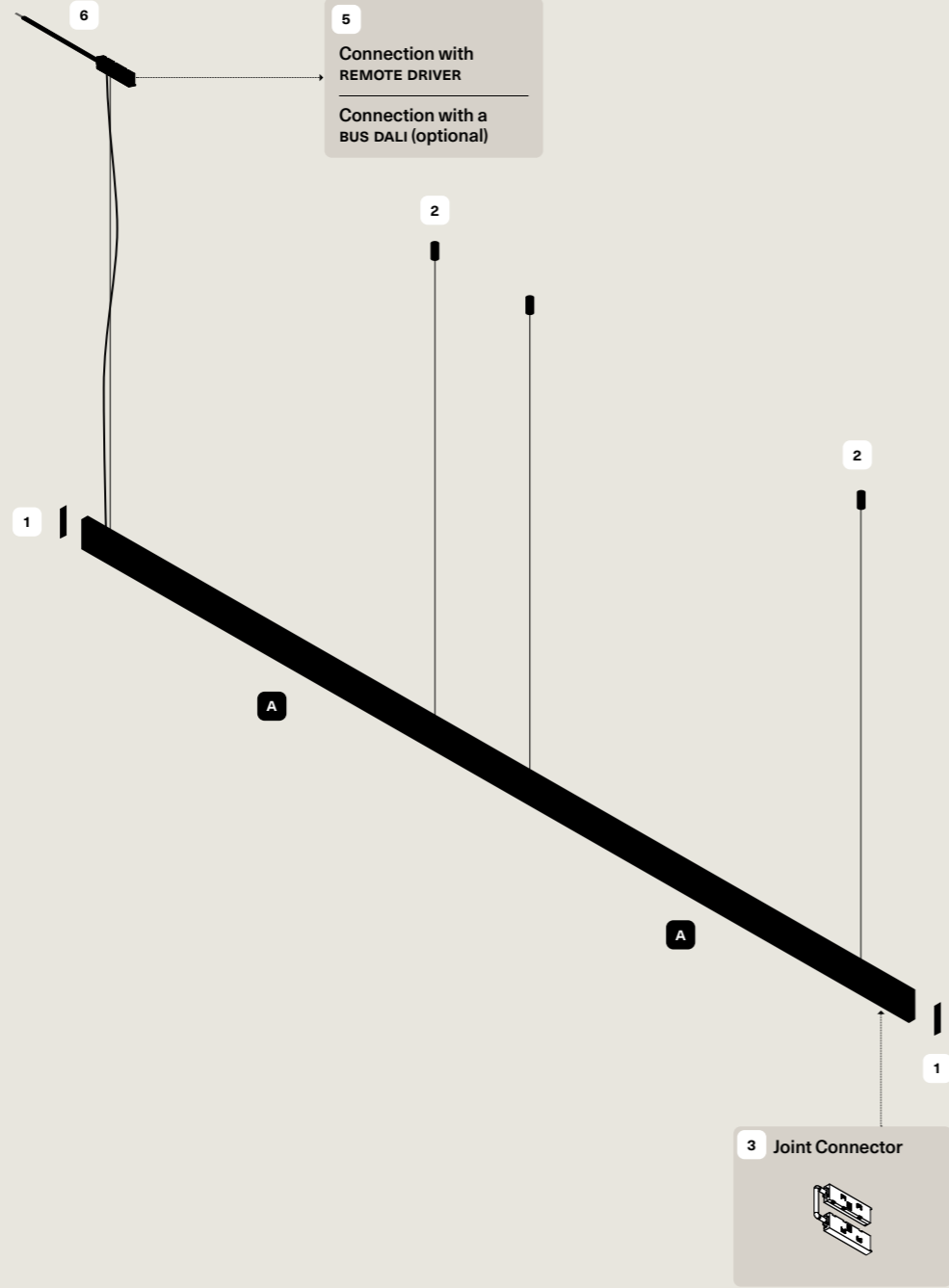

Mono (Down) Emission  
Mono Emissione

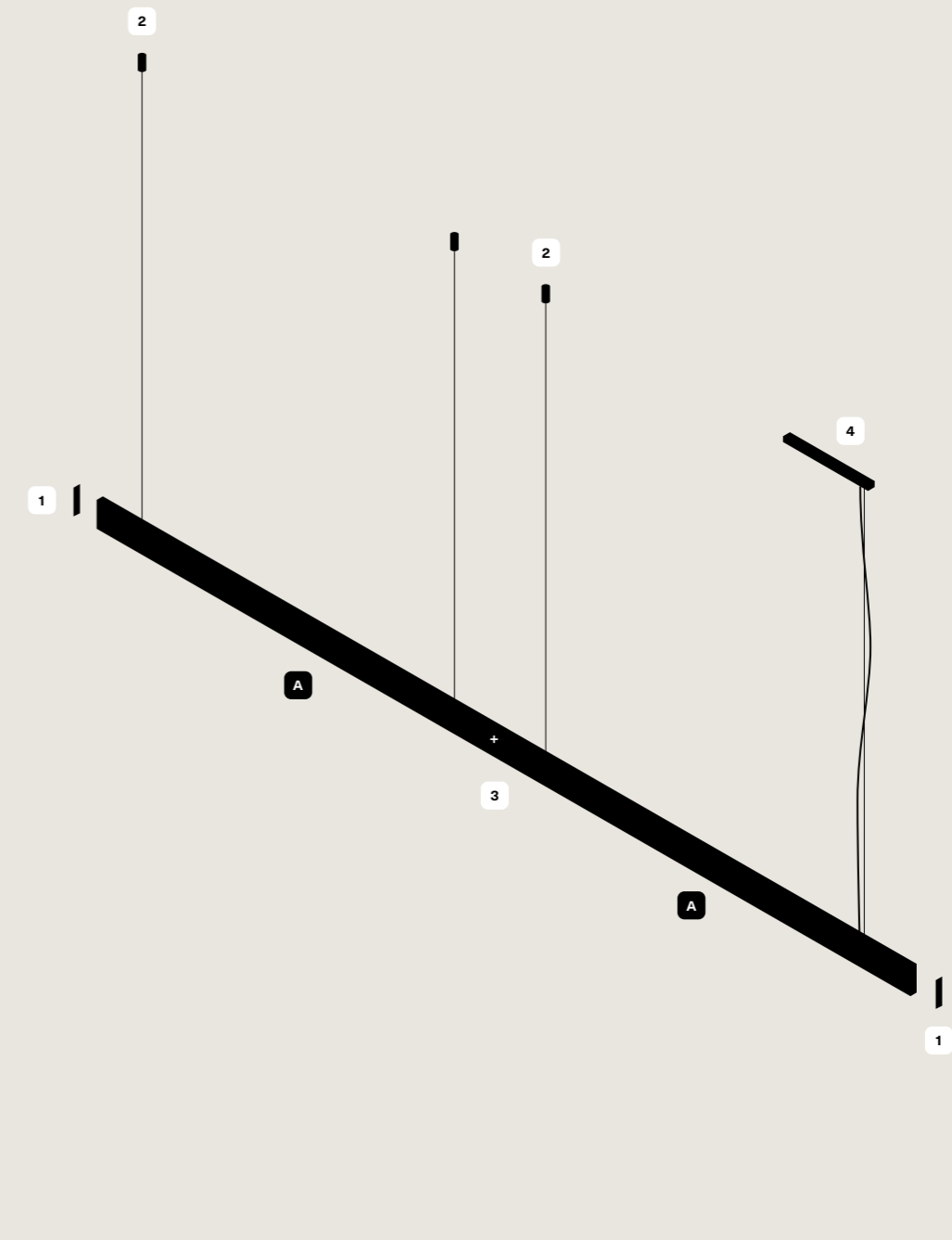

SUSPENDED UP&DOWN



# Lighting Systems

## Track Light Modules NEW

CLIP



SPOTLIGHT



WALLWASHER



GENERAL LIGHT



LIGHT LINE

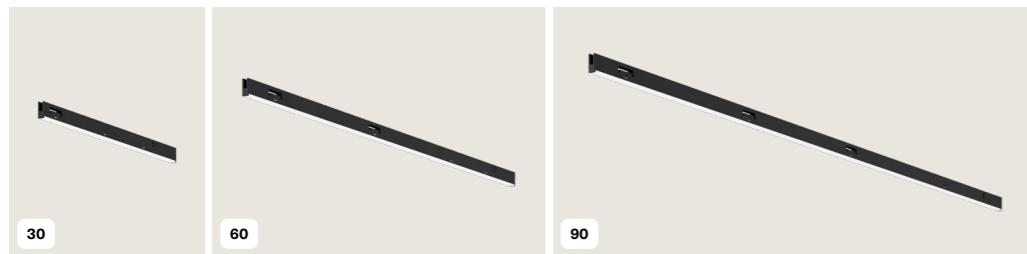

CATEGORY TRACK LIGHT MODULES NEW

DESIGN , 2026

VAT excluded  
IVA esclusa

### Clip



### Description Descrizione

Adapter with integrated clip for connecting and installing pendants on the track. Compatible lamps are shown in the dedicated section below.

Adattatore con clip integrata per collegare e installare le sospensioni sul binario. Le lampade compatibili sono riportate nella sezione dedicata sotto.

### Metal structure Montatura in metallo

- Extra Matte Black Nero Extra Opaco
- Extra Matte Champagne Champagne Extra Opaco
- Extra Matte Black Nero Extra Opaco
- Extra Matte Champagne Champagne Extra Opaco

### Type of dimming Dimmerazione

- DALI
- ON/OFF

### Code Codice

- 001 20
- 001 45
- 101 20
- 101 45

### Euro €

- 95,00
- 100,00
- 55,00
- 60,00

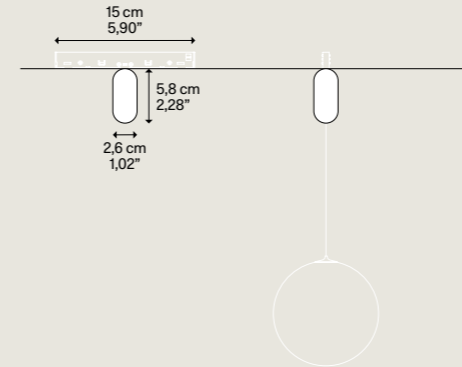

Net weight 65 g / Pack 1  
Peso netto 0,14 lbs / Colli 1



### lamps suitable for

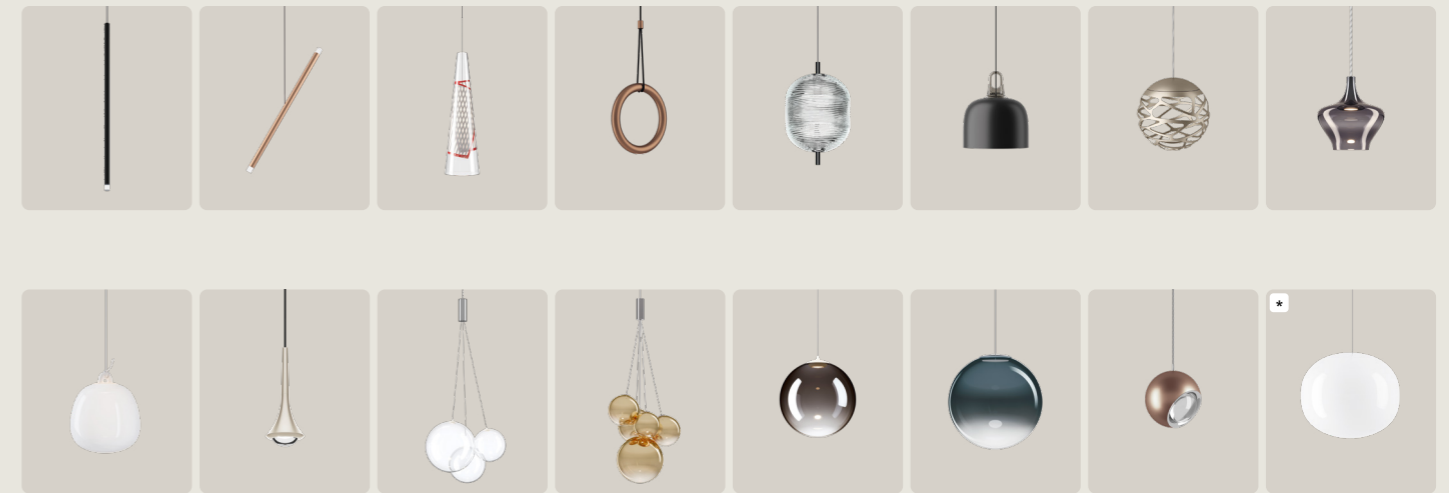

* sospensione on the sul sistema		system must use the following bulbs, which have be ordered separately. deve necessariamente utilizzare le seguenti lampadine, da ordinare separatamente.				VAT excluded IVA esclusa
Light source Sorgente luminosa	Lamp Lampada	System Sistema	Pack Colli	Code Codice	Euro €	
E14 5,1 W	2700 K 570 lm CRI 90 MacAdam 3-Step	14 P. 059	1	-0033	28,00	
E27 9,1 W	2700 K 960 lm CRI 90 MacAdam 3-Step	22 P. 059	1	-0034	33,00	

### 26 SPOTLIGHT

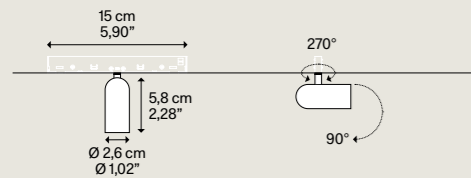

Metal structure Montatura in metallo	Type of dimming Dimmerazione	Code Codice	A Code Codice	B Code Codice	Euro €
Extra Matte Black Nero Extra Opaco	DALI	061 2027	061 2030		195,00
Extra Matte Champagne Champagne Extra Opaco		061 4527	061 4530		210,00
Extra Matte Black Nero Extra Opaco	ON/OFF	161 2027	161 2030		140,00
Extra Matte Champagne Champagne Extra Opaco		161 4527	161 4530		155,00

**Description**  
Descrizione

Compact 48V spotlight for the track system.

Proiettore compatto a 48V per installazione su binario

**Optics**  
Ottica

The product is supplied with three interchangeable optics and an integrated honeycomb louvre.

Il prodotto viene fornito con tre ottiche intercambiabili e filtro honeycomb inclusi.

Light source Sorgente luminosa	A	B
LED 2700 K 4 W 512 lm CRI 90 MacAdam 3-Step		

Light source Sorgente luminosa	A	B
LED 3000 K 4 W 528 lm CRI 90 MacAdam 3-Step		

Beam angle Angolo del fascio	15°	36°	50°	HONEYCOMB LOUVRE
	SPOT	MEDIUM	WIDE	HONEYCOMB LOUVRE

Net weight 60 g  
Peso netto 0,13 lbs  
Pack Colli 1



### 45 SPOTLIGHT

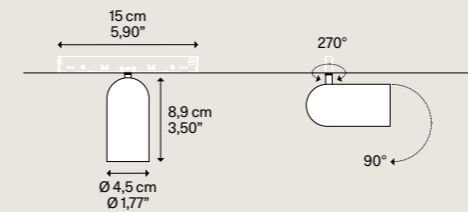

Metal structure Montatura in metallo	Type of dimming Dimmerazione	Code Codice	A Code Codice	B Code Codice	Euro €
Extra Matte Black Nero Extra Opaco	DALI	063 2027	063 2030		240,00
Extra Matte Champagne Champagne Extra Opaco		063 4527	063 4530		260,00
Extra Matte Black Nero Extra Opaco	ON/OFF	163 2027	163 2030		185,00
Extra Matte Champagne Champagne Extra Opaco		163 4527	163 4530		205,00

**Description**  
Descrizione

Compact 48V spotlight for the track system.

Proiettore compatto a 48V per installazione su binario

**Optics**  
Ottica

The product is supplied with three interchangeable optics and an integrated honeycomb louvre.

Il prodotto viene fornito con tre ottiche intercambiabili e filtro honeycomb inclusi.

Light source Sorgente luminosa	A	B
LED 2700 K 12 W 1340 lm CRI 90 MacAdam 3-Step		

Light source Sorgente luminosa	A	B
LED 3000 K 12 W 1390 lm CRI 90 MacAdam 3-Step		

Beam angle Angolo del fascio	15°	36°	50°	HONEYCOMB LOUVRE
	SPOT	MEDIUM	WIDE	HONEYCOMB LOUVRE

Net weight 220 g  
Peso netto 0,48 lbs  
Pack Colli 1



### 35 SPOTLIGHT

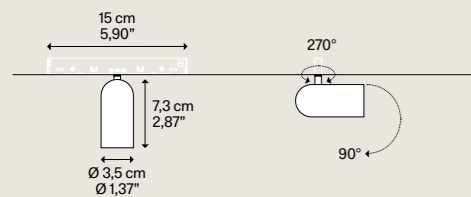

Metal structure Montatura in metallo	Type of dimming Dimmerazione	Code Codice	A Code Codice	B Code Codice	Euro €
Extra Matte Black Nero Extra Opaco	DALI	062 2027	062 2030		215,00
Extra Matte Champagne Champagne Extra Opaco		062 4527	062 4530		235,00
Extra Matte Black Nero Extra Opaco	ON/OFF	162 2027	162 2030		160,00
Extra Matte Champagne Champagne Extra Opaco		162 4527	162 4530		180,00

**Description**  
Descrizione

Compact 48V spotlight for the track system.

Proiettore compatto a 48V per installazione su binario

**Optics**  
Ottica

The product is supplied with three interchangeable optics and an integrated honeycomb louvre.

Il prodotto viene fornito con tre ottiche intercambiabili e filtro honeycomb inclusi.

Light source Sorgente luminosa	A	B
LED 2700 K 8 W 768 lm CRI 90 MacAdam 3-Step		

Light source Sorgente luminosa	A	B
LED 3000 K 8 W 792 lm CRI 90 MacAdam 3-Step		

Beam angle Angolo del fascio	15°	36°	50°	HONEYCOMB LOUVRE
	SPOT	MEDIUM	WIDE	HONEYCOMB LOUVRE

Net weight 120 g  
Peso netto 0,26 lbs  
Pack Colli 1

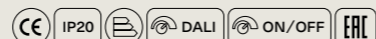

### WALLWASHER

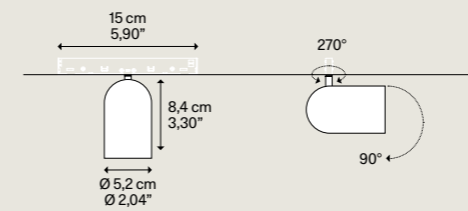

Metal structure Montatura in metallo	Type of dimming Dimmerazione	Code Codice	A Code Codice	B Code Codice	Euro €
Extra Matte Black Nero Extra Opaco	DALI	051 2027	051 2030		240,00
Extra Matte Champagne Champagne Extra Opaco		051 4527	051 4530		260,00
Extra Matte Black Nero Extra Opaco	ON/OFF	151 2027	151 2030		185,00
Extra Matte Champagne Champagne Extra Opaco		151 4527	151 4530		205,00

**Description**  
Descrizione

Compact 48V wallwasher spotlight for installation on the track system.

Proiettore compatto wallwasher a 48V per installazione su binario

**Optics**  
Ottica

The wallwasher optic is designed to provide uniform illumination of walls and vertical surfaces.

L'ottica wallwasher è progettata per garantire un'illuminazione uniforme di pareti e superfici verticali.

Light source Sorgente luminosa	A	B
LED 2700 K 10 W 1970 lm CRI 90 MacAdam 3-Step		

Light source Sorgente luminosa	A	B
LED 3000 K 10 W 2100 lm CRI 90 MacAdam 3-Step		

Beam angle Angolo del fascio	WALLWASHER
	WALLWASHER

Net weight 260 g  
Peso netto 0,57 lbs  
Pack Colli 1



GENERAL LIGHT

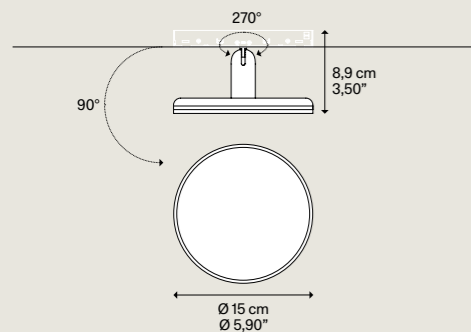

Metal structure Montatura in metallo	Type of dimming Dimmerazione	Code Codice	<b>A</b> Code Codice	<b>B</b> Code Codice	Euro €
● Extra Matte Black Nero Extra Opaco		031 2027	031 2030	185,00	
● Extra Matte Champagne Champagne Extra Opaco		031 4527	031 4530	195,00	
● Extra Matte Black Nero Extra Opaco		131 2027	131 2030	140,00	
● Extra Matte Champagne Champagne Extra Opaco		131 4527	131 4530	150,00	

Description  
Descrizione

Adjustable 48V general light module with microprismatic diffuser for the track system.

Modulo orientabile a luce diffusa 48V con diffusore microprismatico, per installazione su binario

Beam angle  
Angolo del fascio

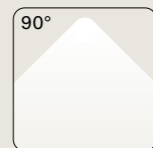

WIDE

Light source  
Sorgente luminosa

LED  
2700 K  
12 W  
1896 lm  
CRI 90  
MacAdam 3-Step

Light source  
Sorgente luminosa

LED  
3000 K  
12 W  
1902 lm  
CRI 90  
MacAdam 3-Step

Net weight 360 g  
Peso netto 0,79 lbs  
Pack Colli 1



30 LIGHT LINE

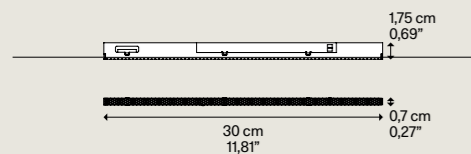
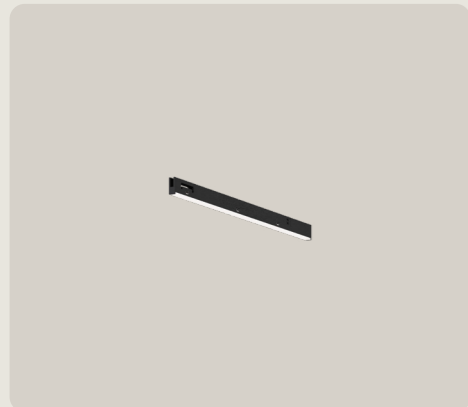

Metal structure Montatura in metallo	Type of dimming Dimmerazione	Code Codice	<b>A</b> Code Codice	<b>B</b> Code Codice	Euro €
● Extra Matte Black Nero Extra Opaco		091 27	091 30	165,00	
● Extra Matte Black Nero Extra Opaco		191 27	191 30	110,00	

Description  
Descrizione

48V light line for installation on the track system, 30 cm/11,81" length.

Linea di luce a 48V per installazione su binario lunghezza 30 cm/11,81".

Beam angle  
Angolo del fascio



EXTRA WIDE

Light source  
Sorgente luminosa

LED  
2700 K  
4 W  
532 lm  
CRI 90  
MacAdam 3-Step

Light source  
Sorgente luminosa

LED  
3000 K  
4 W  
544 lm  
CRI 90  
MacAdam 3-Step

Net weight 60 g  
Peso netto 0,13 lbs  
Pack Colli 1



60 LIGHT LINE

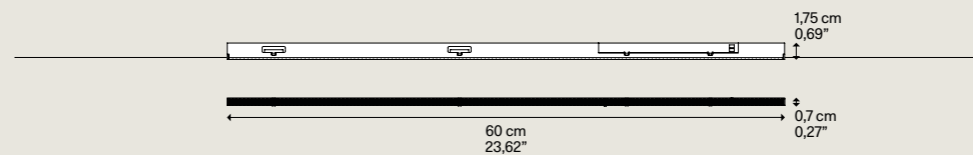

Net weight 100 g  
Peso netto 0,22 lbs  
Pack Colli 1



Metal structure Montatura in metallo	Type of dimming Dimmerazione	Code Codice	<b>A</b> Code Codice	<b>B</b> Code Codice	Euro €
● Extra Matte Black Nero Extra Opaco		092 27	092 30	190,00	
● Extra Matte Black Nero Extra Opaco		192 27	192 30	135,00	

Description  
Descrizione

48V light line for installation on the track system, 60 cm/23,62" length.

Linea di luce a 48V per installazione su binario lunghezza 60 cm/23,62".

Beam angle  
Angolo del fascio



EXTRA WIDE

Light source  
Sorgente luminosa

LED  
2700 K  
8 W  
1064 lm  
CRI 90  
MacAdam 3-Step

Light source  
Sorgente luminosa

LED  
3000 K  
8 W  
1088 lm  
CRI 90  
MacAdam 3-Step

90 LIGHT LINE

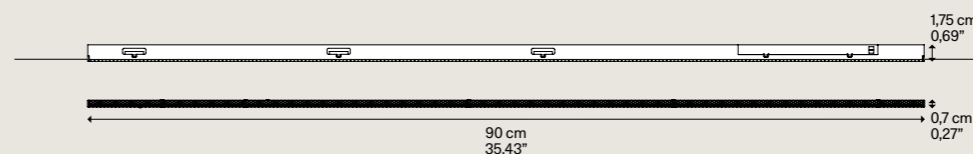

Net weight 145 g  
Peso netto 0,31 lbs  
Pack Colli 1



Metal structure Montatura in metallo	Type of dimming Dimmerazione	Code Codice	<b>A</b> Code Codice	<b>B</b> Code Codice	Euro €
● Extra Matte Black Nero Extra Opaco		093 27	093 30	220,00	
● Extra Matte Black Nero Extra Opaco		193 27	193 30	165,00	

Description  
Descrizione

48V light line for installation on the track system, 90 cm/35,43" length.

Linea di luce a 48V per installazione su binario lunghezza 90 cm/35,43".

Beam angle  
Angolo del fascio



EXTRA WIDE

Light source  
Sorgente luminosa

LED  
2700 K  
12 W  
1596 lm  
CRI 90  
MacAdam 3-Step

Light source  
Sorgente luminosa

LED  
3000 K  
12 W  
1632 lm  
CRI 90  
MacAdam 3-Step